

Chapter 7

Wireless and Mobile Networks



Ch. 7: Wireless and Mobile Networks

Background:

- # wireless (mobile) phone subscribers now exceeds # wired phone subscribers (5-to-1)!
- # wireless Internet-connected devices equals # wireline Internet-connected devices
 - laptops, Internet-enabled phones promise anytime untethered Internet access
- two important (but different) challenges
 - *wireless*: communication over wireless link
 - *mobility*: handling the mobile user who changes point of attachment to network

Chapter 7 outline

7.1 Introduction

Wireless

7.2 Wireless links, characteristics

- CDMA

7.3 IEEE 802.11 wireless LANs (“Wi-Fi”)

7.4 Cellular Internet Access

- architecture
- standards (e.g., 3G, LTE)

Mobility

7.5 Principles: addressing and routing to mobile users

7.6 Mobile IP

7.7 Handling mobility in cellular networks

7.8 Mobility and higher-layer protocols

Elements of a wireless network

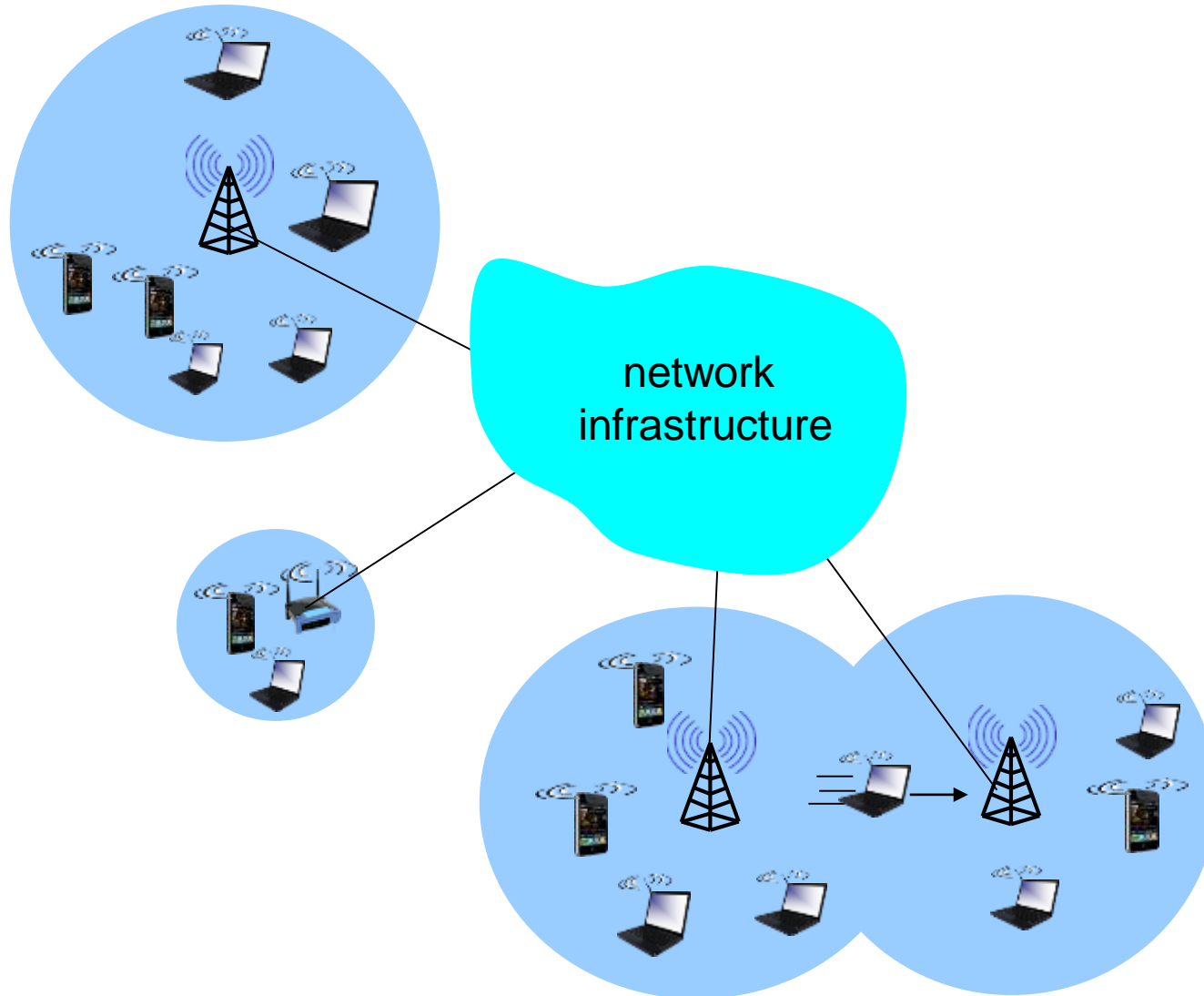

Elements of a wireless network

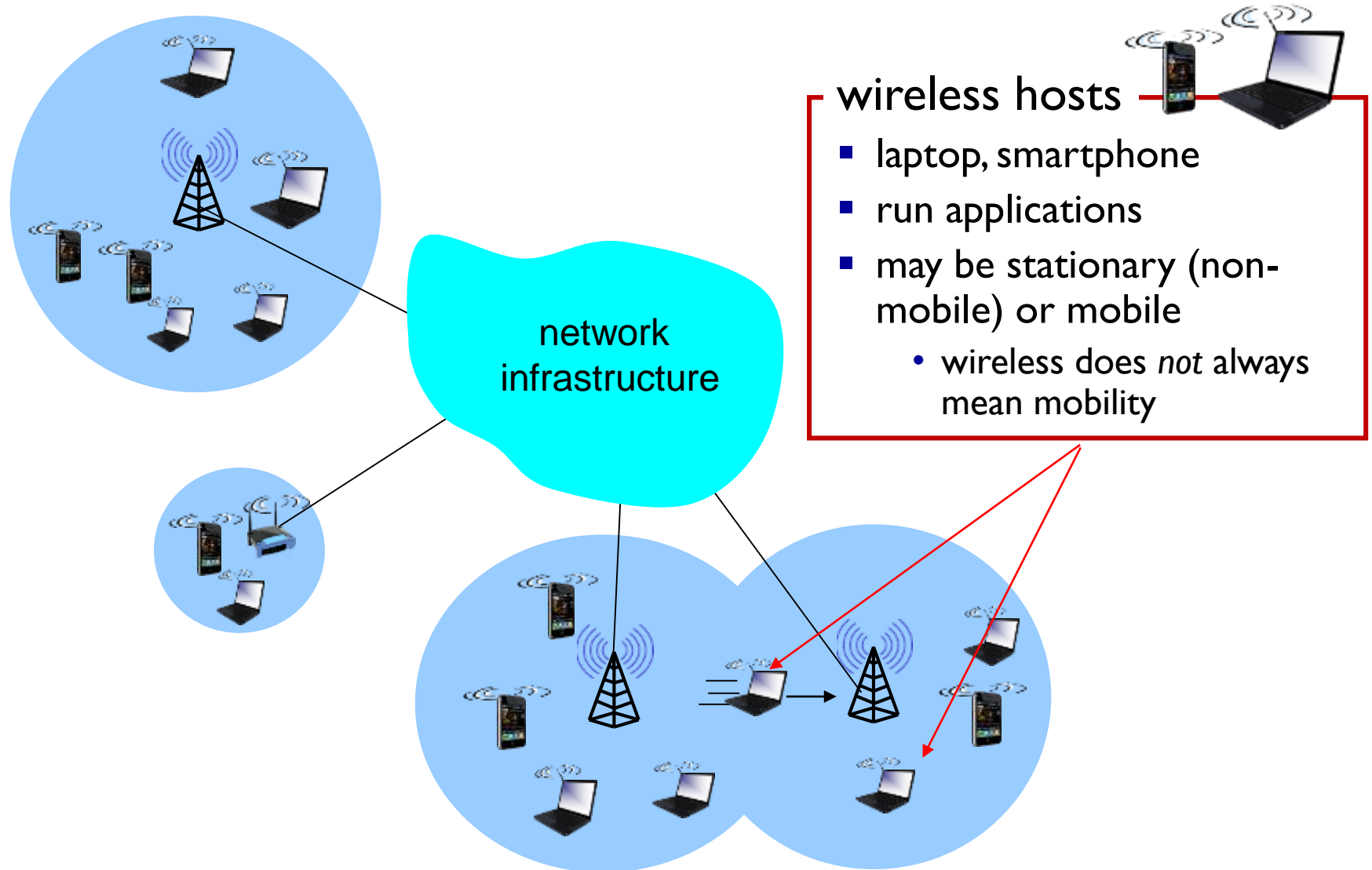

Elements of a wireless network

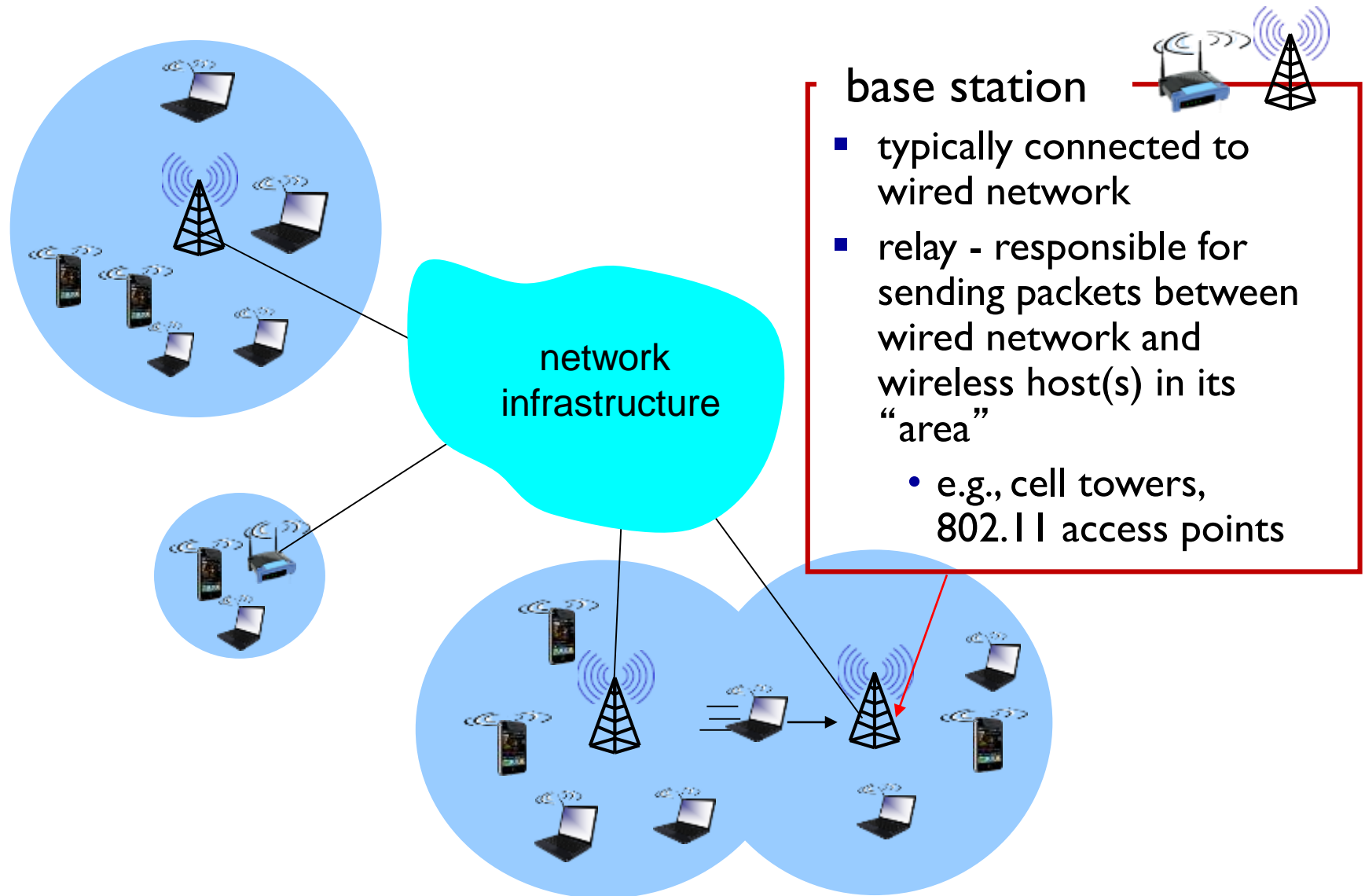

Elements of a wireless network

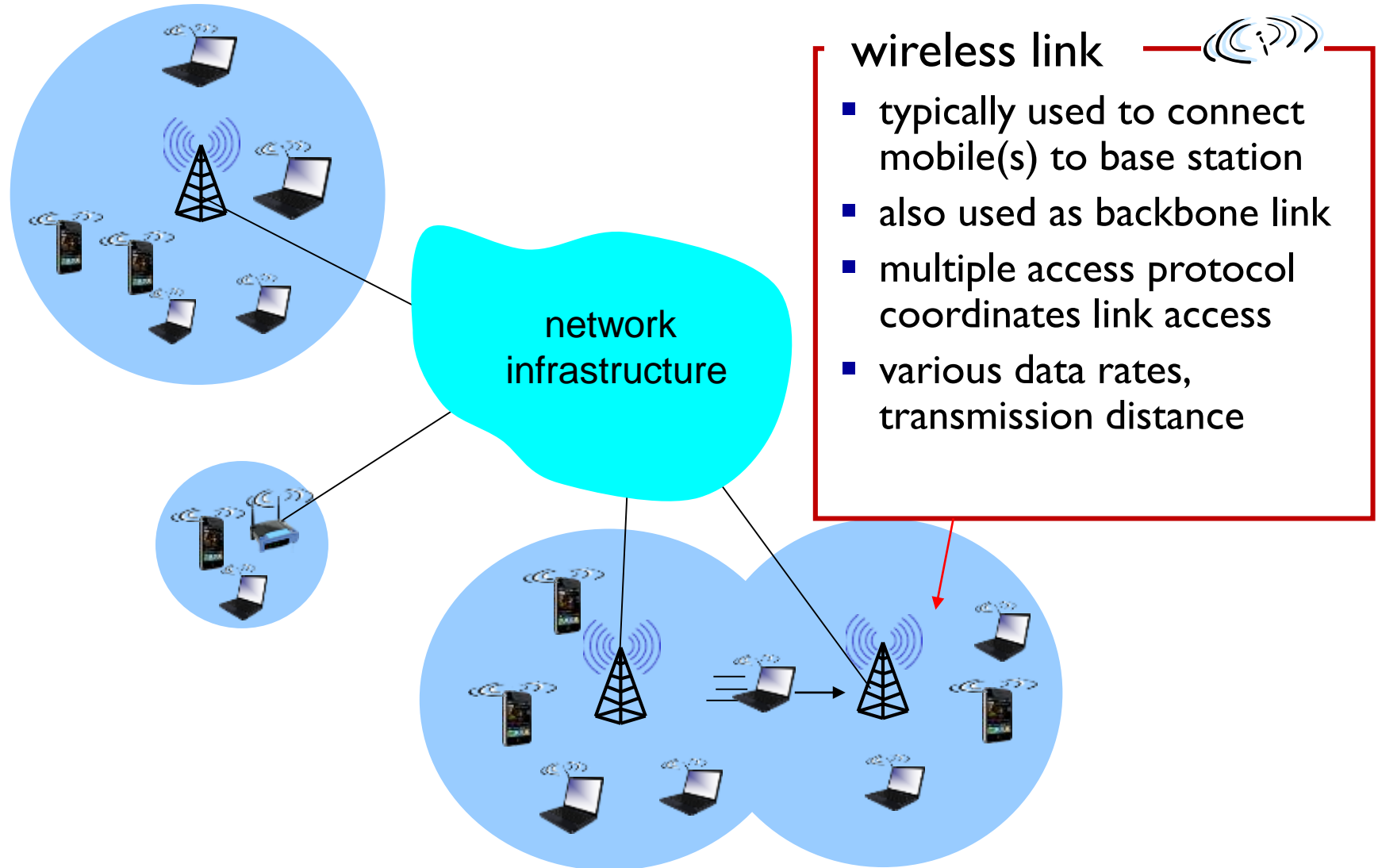

Characteristics of selected wireless links

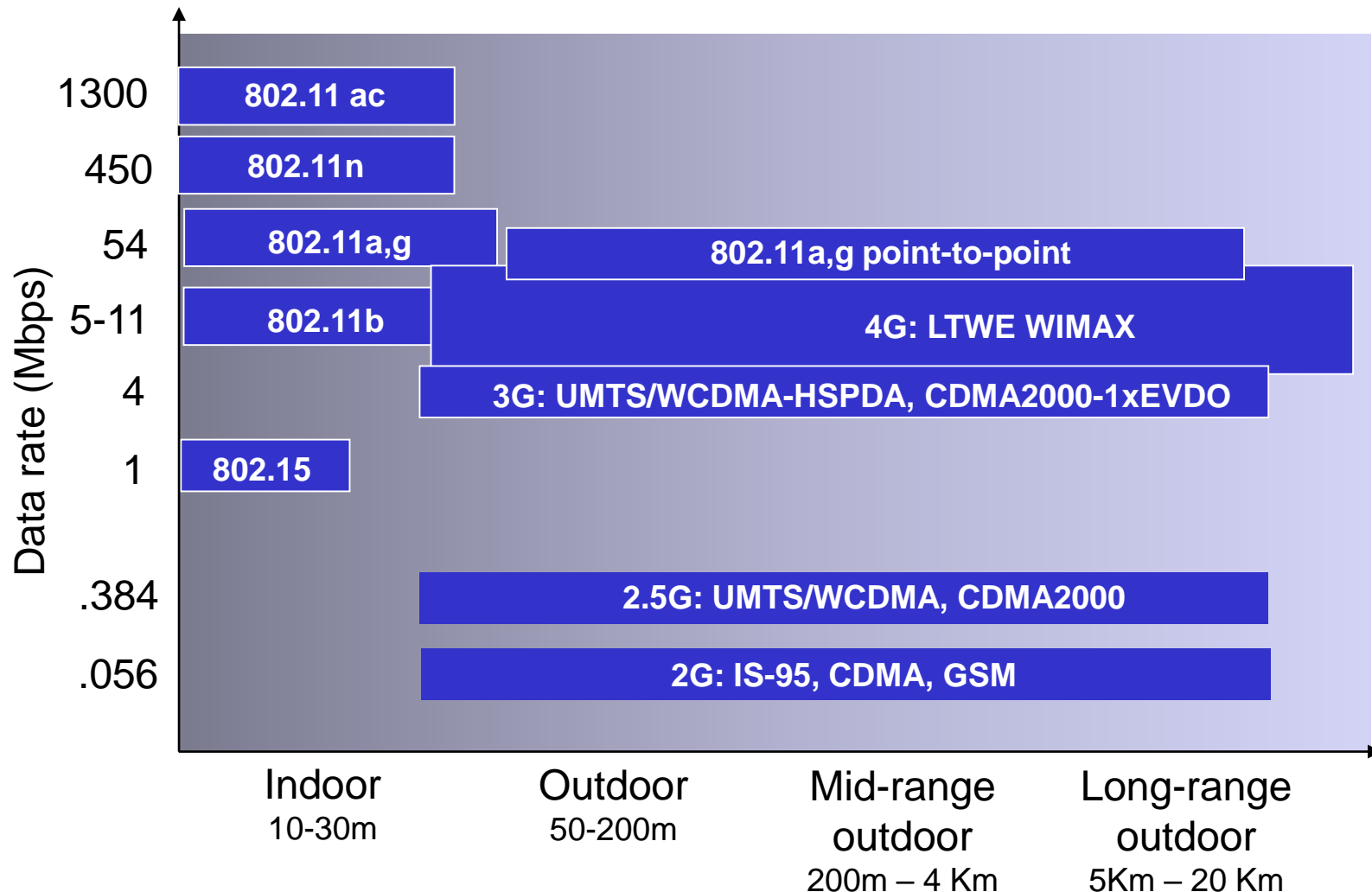

Elements of a wireless network

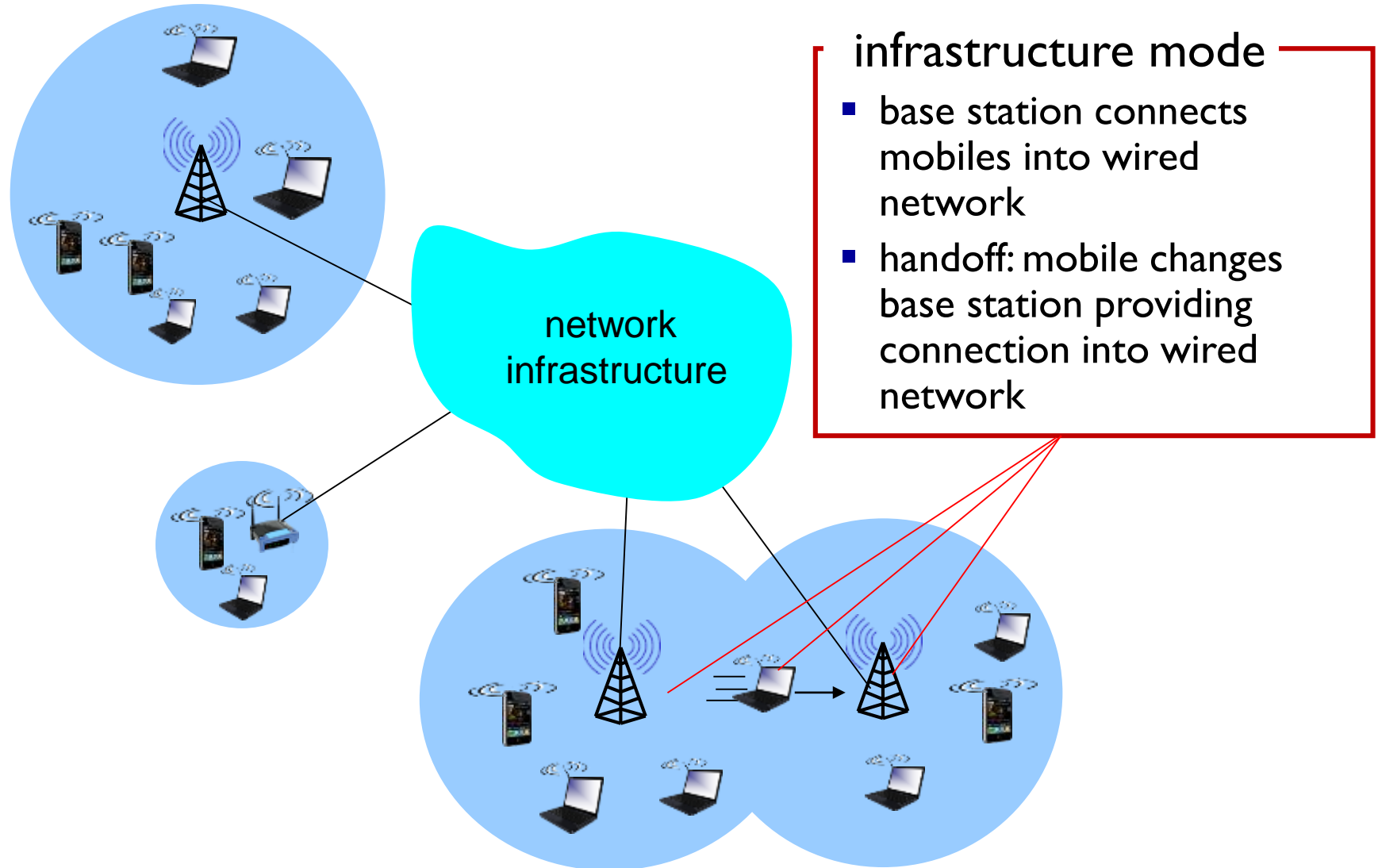

Elements of a wireless network

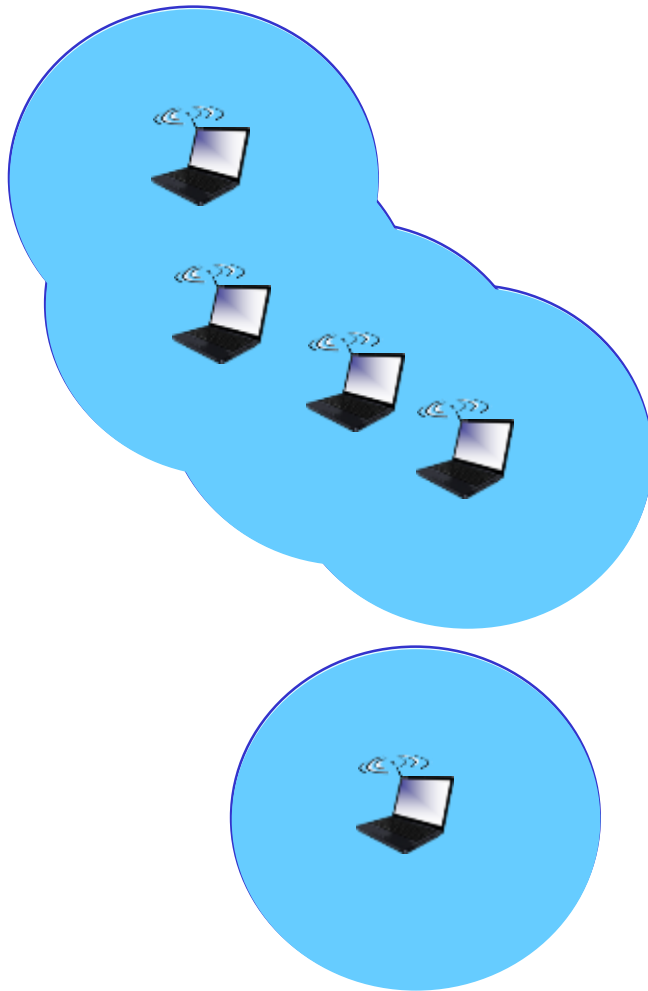

ad hoc mode

- no base stations
- nodes can only transmit to other nodes within link coverage
- nodes organize themselves into a network: route among themselves

Wireless network taxonomy

	single hop	multiple hops
infrastructure (e.g., APs)	host connects to base station (WiFi, WiMAX, cellular) which connects to larger Internet	host may have to relay through several wireless nodes to connect to larger Internet: <i>mesh net</i>
no infrastructure	no base station, no connection to larger Internet (Bluetooth, ad hoc nets)	no base station, no connection to larger Internet. May have to relay to reach other a given wireless node MANET, VANET

Chapter 7 outline

7.1 Introduction

Wireless

7.2 Wireless links, characteristics

- CDMA

7.3 IEEE 802.11 wireless LANs (“Wi-Fi”)

7.4 Cellular Internet Access

- architecture
- standards (e.g., 3G, LTE)

Mobility

7.5 Principles: addressing and routing to mobile users

7.6 Mobile IP

7.7 Handling mobility in cellular networks

7.8 Mobility and higher-layer protocols

Wireless Link Characteristics (I)

important differences from wired link

- *decreased signal strength*: radio signal attenuates as it propagates through matter (path loss)
- *interference from other sources*: standardized wireless network frequencies (e.g., 2.4 GHz) shared by other devices (e.g., phone); devices (motors) interfere as well
- *multipath propagation*: radio signal reflects off objects ground, arriving at destination at slightly different times

.... make communication across (even a point to point) wireless link much more “difficult”

Wireless Link Characteristics (2)

- SNR: signal-to-noise ratio
 - larger SNR – easier to extract signal from noise (a “good thing”)
- *SNR versus BER tradeoffs*
 - *given physical layer*: increase power \rightarrow increase SNR \rightarrow decrease BER
 - *given SNR*: choose physical layer that meets BER requirement, giving highest throughput
 - SNR may change with mobility: dynamically adapt physical layer (modulation technique, rate)

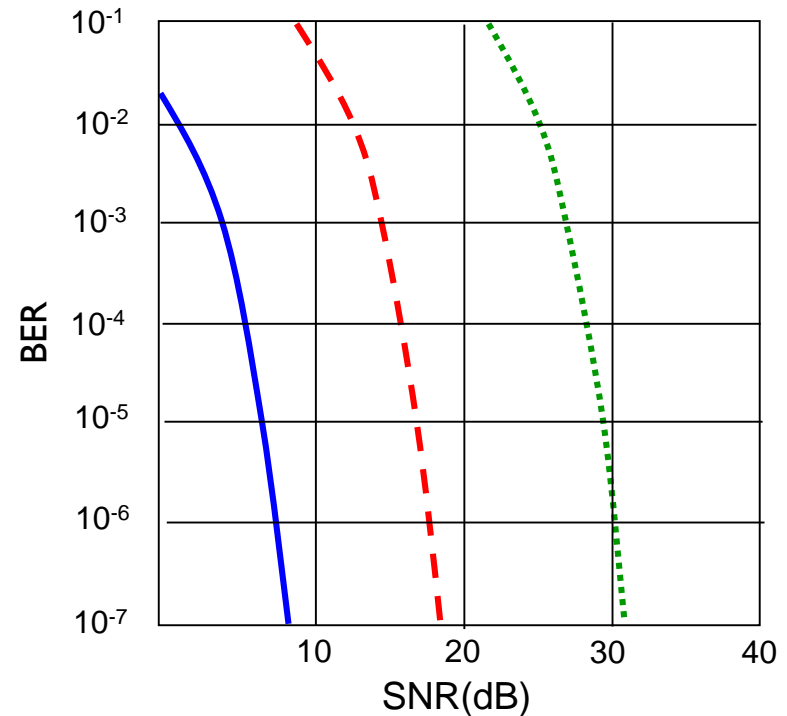

- QAM256 (8 Mbps)
- - - QAM16 (4 Mbps)
- BPSK (1 Mbps)

Wireless network characteristics

Multiple wireless senders and receivers create additional problems (beyond multiple access):

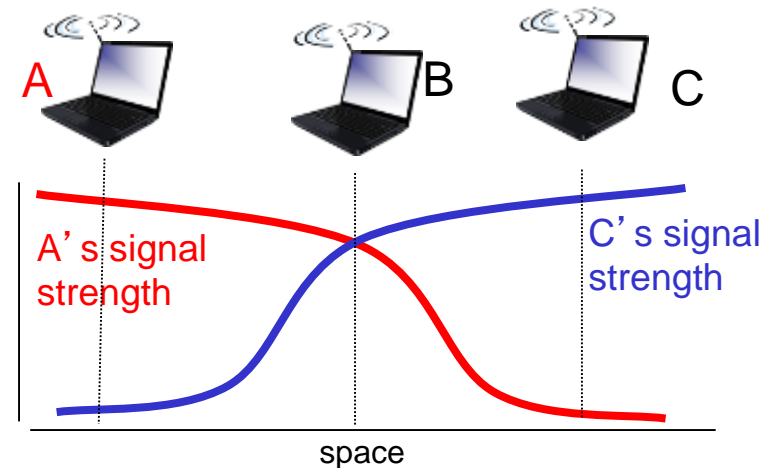
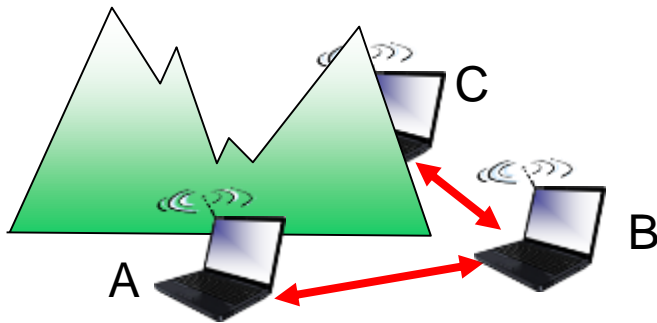

Hidden terminal problem

- B, A hear each other
- B, C hear each other
- A, C can not hear each other means A, C unaware of their interference at B

Signal attenuation:

- B, A hear each other
- B, C hear each other
- A, C can not hear each other interfering at B

Code Division Multiple Access (CDMA)

- unique “code” assigned to each user; i.e., code set partitioning
 - all users share same frequency, but each user has own “chipping” sequence (i.e., code) to encode data
 - allows multiple users to “coexist” and transmit simultaneously with minimal interference (if codes are “orthogonal”)
- *encoded signal* = (original data) \times (chipping sequence)
- *decoding*: inner-product of encoded signal and chipping sequence

CDMA encode/decode

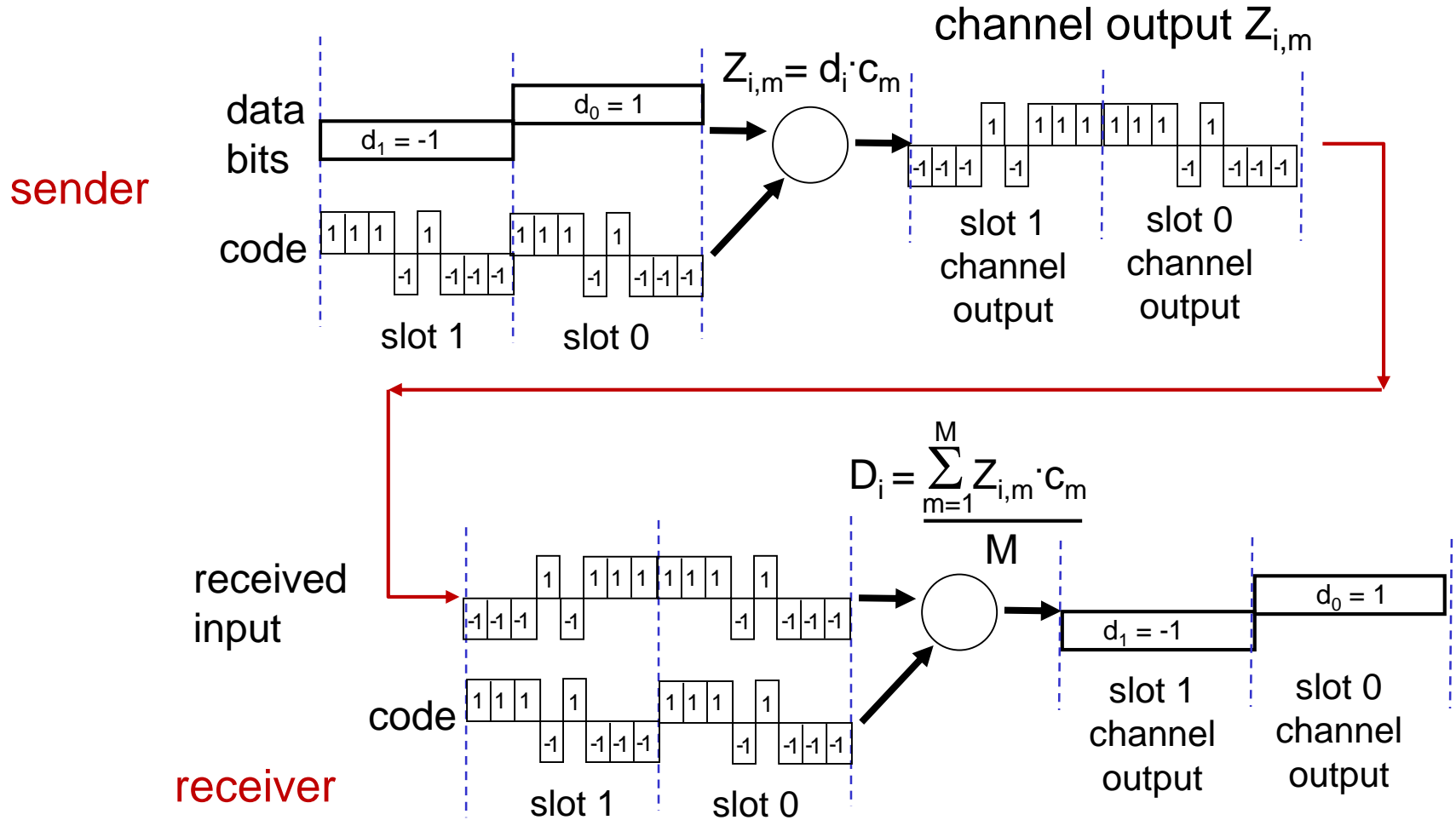

CDMA: two-sender interference

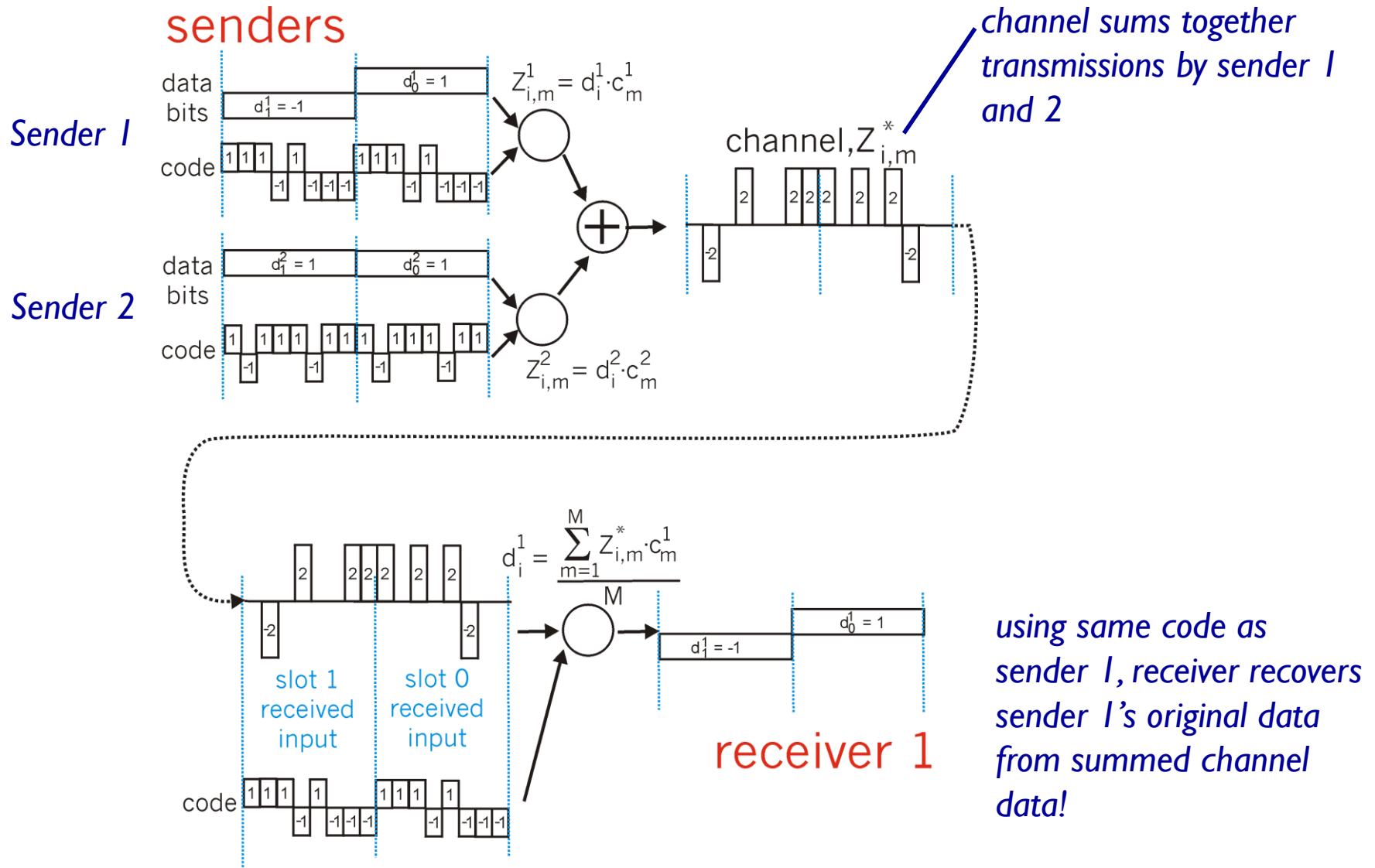

Chapter 7 outline

7.1 Introduction

Wireless

7.2 Wireless links, characteristics

- CDMA

7.3 IEEE 802.11 wireless LANs (“Wi-Fi”)

7.4 Cellular Internet Access

- architecture
- standards (e.g., 3G, LTE)

Mobility

7.5 Principles: addressing and routing to mobile users

7.6 Mobile IP

7.7 Handling mobility in cellular networks

7.8 Mobility and higher-layer protocols

IEEE 802.11 Wireless LAN

802.11b

- 2.4-5 GHz unlicensed spectrum
- up to 11 Mbps
- direct sequence spread spectrum (DSSS) in physical layer
 - all hosts use same chipping code

802.11a

- 5-6 GHz range
- up to 54 Mbps

802.11g

- 2.4-5 GHz range
- up to 54 Mbps

802.11n: multiple antennae

- 2.4-5 GHz range
- up to 200 Mbps

-
- all use CSMA/CA for multiple access
 - all have base-station and ad-hoc network versions

802.11 LAN architecture

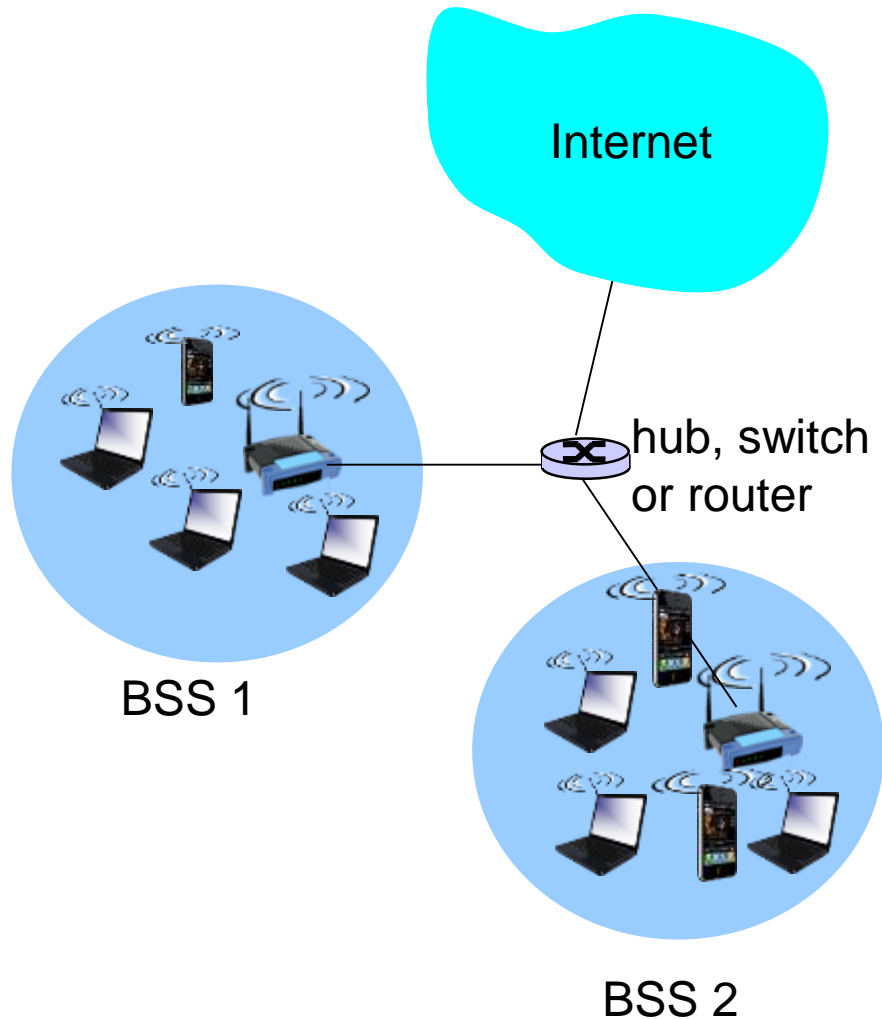

- wireless host communicates with base station
 - base station = access point (AP)
- Basic Service Set (BSS) (aka “cell”) in infrastructure mode contains:
 - wireless hosts
 - access point (AP): base station
 - ad hoc mode: hosts only

802.11: Channels, association

- 802.11b: 2.4GHz-2.485GHz spectrum divided into 11 channels at different frequencies
 - AP admin chooses frequency for AP
 - interference possible: channel can be same as that chosen by neighboring AP!
- host: must *associate* with an AP
 - scans channels, listening for *beacon frames* containing AP's name (SSID) and MAC address
 - selects AP to associate with
 - may perform authentication [Chapter 8]
 - will typically run DHCP to get IP address in AP's subnet

802.11: passive/active scanning

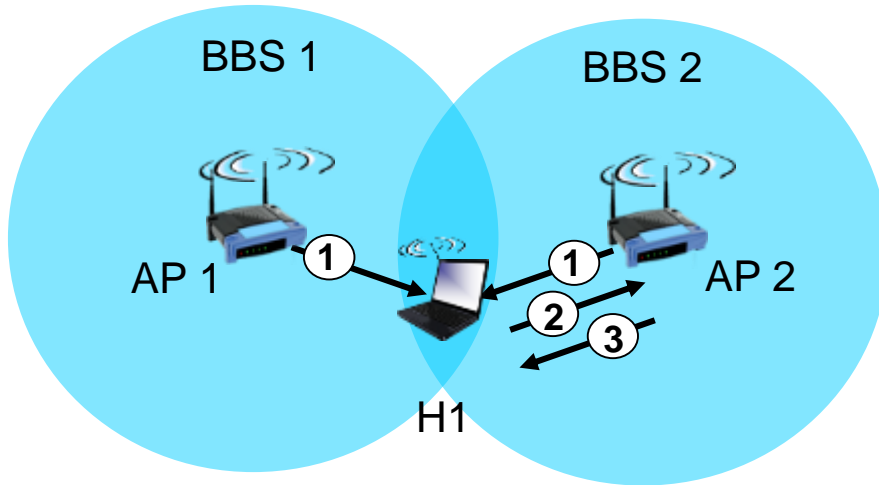

passive scanning:

- (1) beacon frames sent from APs
- (2) association Request frame sent: H1 to selected AP
- (3) association Response frame sent from selected AP to H1

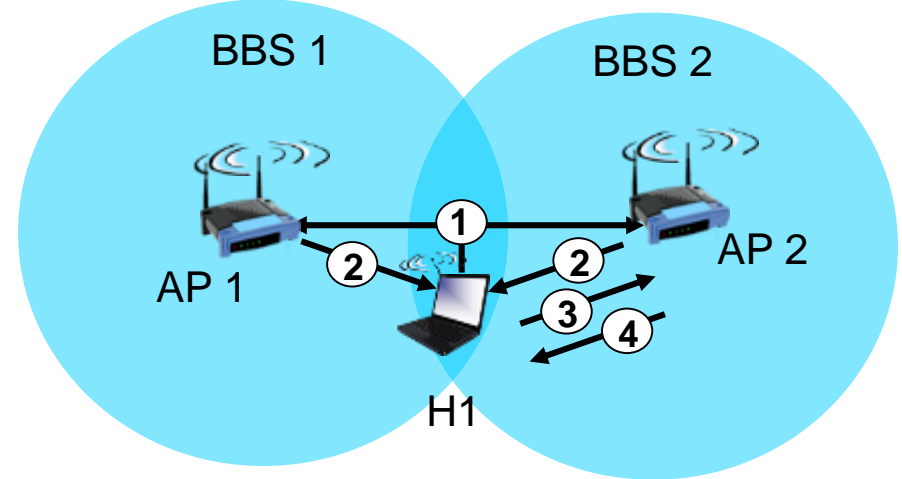

active scanning:

- (1) Probe Request frame broadcast from H1
- (2) Probe Response frames sent from APs
- (3) Association Request frame sent: H1 to selected AP
- (4) Association Response frame sent from selected AP to H1

IEEE 802.11: multiple access

- avoid collisions: 2⁺ nodes transmitting at same time
- 802.11: CSMA - sense before transmitting
 - don't collide with ongoing transmission by other node
- 802.11: *no* collision detection!
 - difficult to receive (sense collisions) when transmitting due to weak received signals (fading)
 - can't sense all collisions in any case: hidden terminal, fading
 - goal: *avoid collisions*: CSMA/C(ollision)A(avoidance)

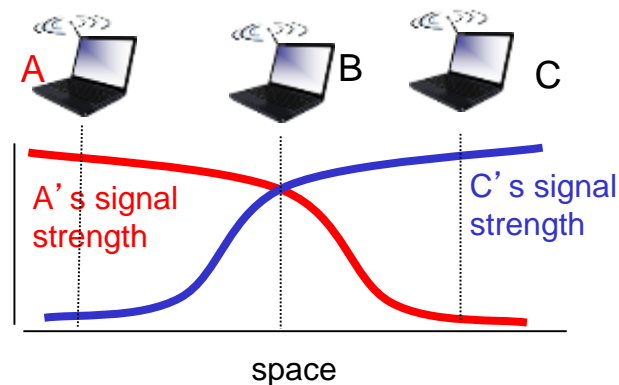
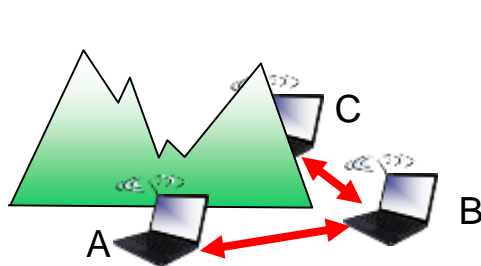

IEEE 802.11 MAC Protocol: CSMA/CA

802.11 sender

- 1 if sense channel idle for **DIFS** (Distributed Inter Frame Space) then
transmit entire frame (no CD)
- 2 if sense channel busy then
start random backoff time
timer counts down while channel idle
transmit when timer expires
if no ACK, increase random backoff interval,
repeat 2

802.11 receiver

- if frame received OK
return ACK after **SIFS** (Short Inter Frame Space) - ACK needed due to hidden terminal problem

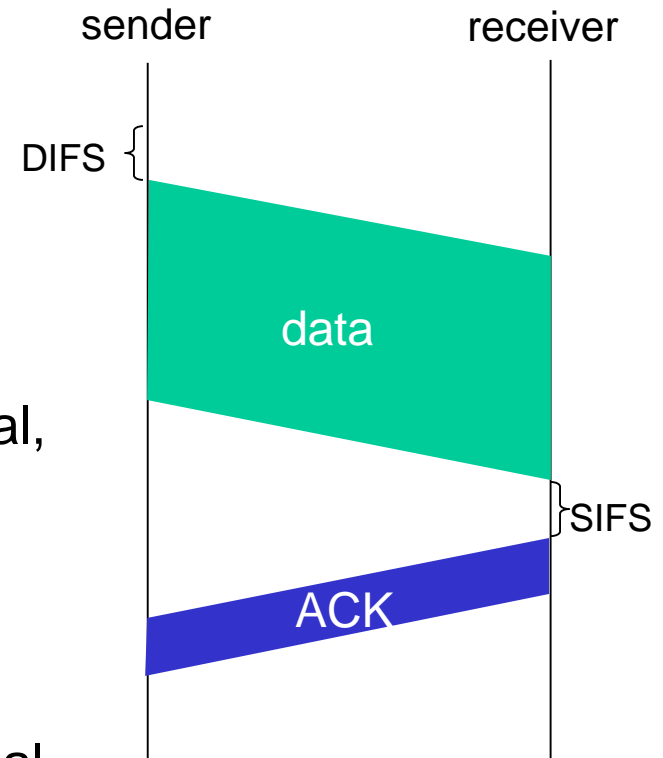

Avoiding collisions (more)

idea: allow sender to “reserve” channel rather than random access of data frames: avoid collisions of long data frames

- sender first transmits *small* request-to-send (RTS) packets to BS using CSMA
 - RTSs may still collide with each other (but they’ re short)
- BS broadcasts clear-to-send CTS in response to RTS
- CTS heard by all nodes
 - sender transmits data frame
 - other stations defer transmissions

*avoid data frame collisions completely
using small reservation packets!*

Collision Avoidance: RTS-CTS exchange

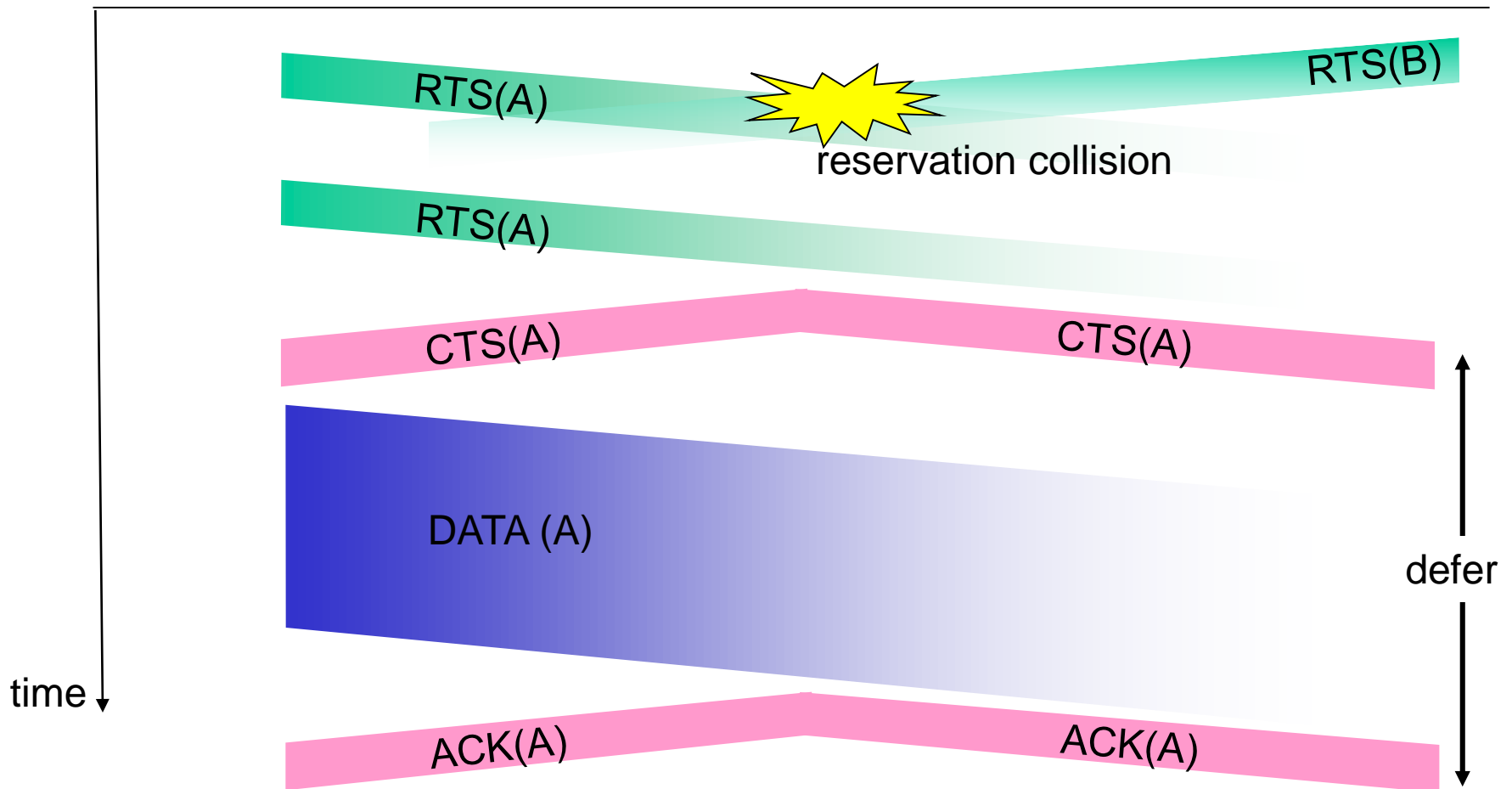

802.11: mobility within same subnet

- HI remains in same IP subnet: IP address can remain same
- switch: which AP is associated with HI?
 - self-learning (Ch. 6): switch will see frame from HI and “remember” which switch port can be used to reach HI

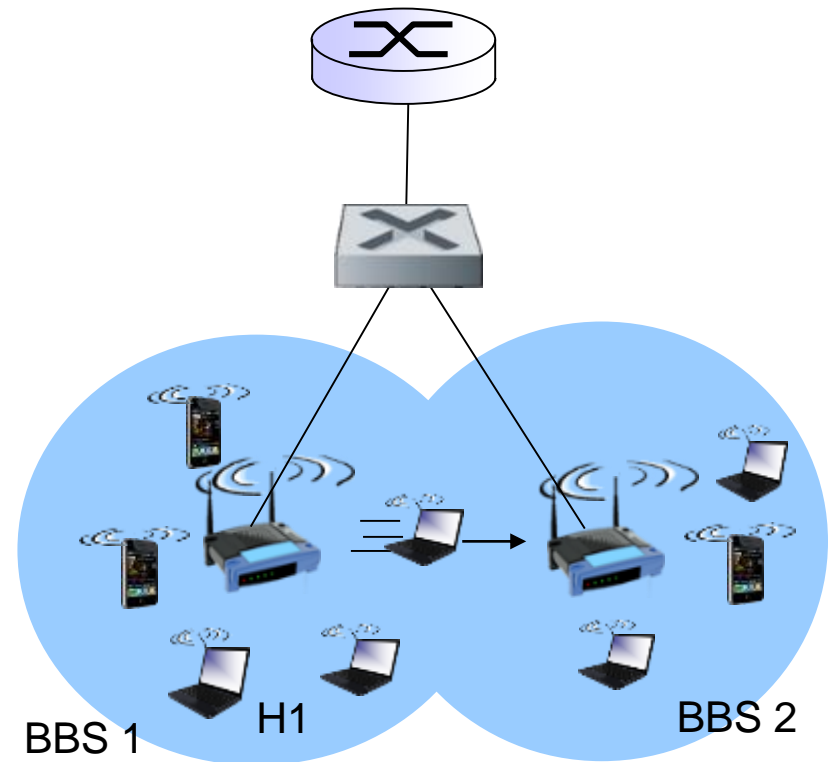

802.11: advanced capabilities

power management

- node-to-AP: “I am going to sleep until next beacon frame”
 - AP knows not to transmit frames to this node
 - node wakes up before next beacon frame
- beacon frame: contains list of mobiles with AP-to-mobile frames waiting to be sent
 - node will stay awake if AP-to-mobile frames to be sent; otherwise sleep again until next beacon frame

802.15: personal area network

- less than 10 m diameter
- replacement for cables (mouse, keyboard, headphones)
- ad hoc: no infrastructure
- master/slaves:
 - slaves request permission to send (to master)
 - master grants requests
- 802.15: evolved from Bluetooth specification
 - 2.4-2.5 GHz radio band
 - up to 721 kbps

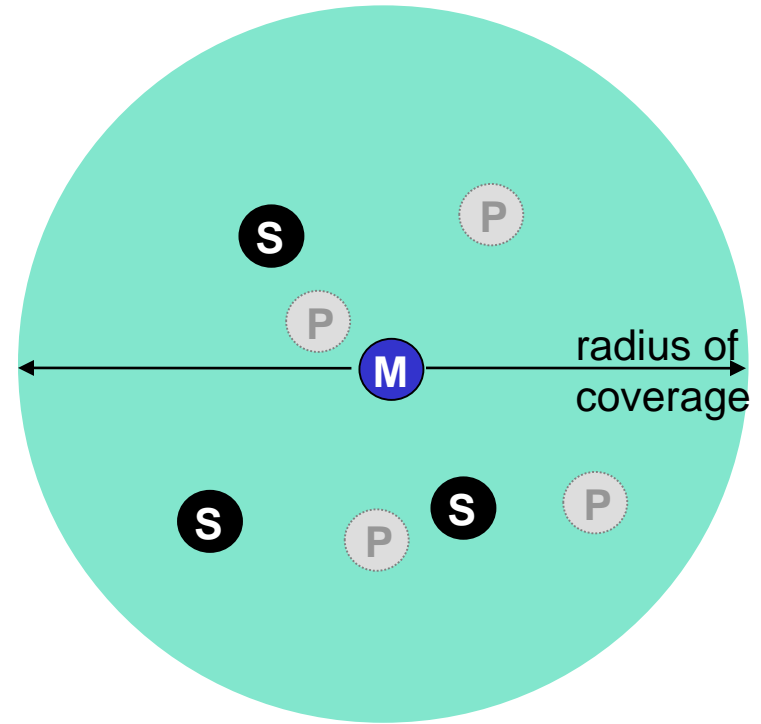

- M Master device
- S Slave device
- P Parked device (inactive)

Chapter 7 outline

7.1 Introduction

Wireless

7.2 Wireless links, characteristics

- CDMA

7.3 IEEE 802.11 wireless LANs (“Wi-Fi”)

7.4 Cellular Internet access

- architecture
- standards (e.g., 3G, LTE)

Mobility

7.5 Principles: addressing and routing to mobile users

7.6 Mobile IP

7.7 Handling mobility in cellular networks

7.8 Mobility and higher-layer protocols

Components of cellular network architecture

cell

- ❖ covers geographical region
- ❖ *base station* (BS) analogous to 802.11 AP
- ❖ *mobile users* attach to network through BS
- ❖ *air-interface*: physical and link layer protocol between mobile and BS

MSC

- ❖ connects cells to wired tel. net.
- ❖ manages call setup (more later!)
- ❖ handles mobility (more later!)

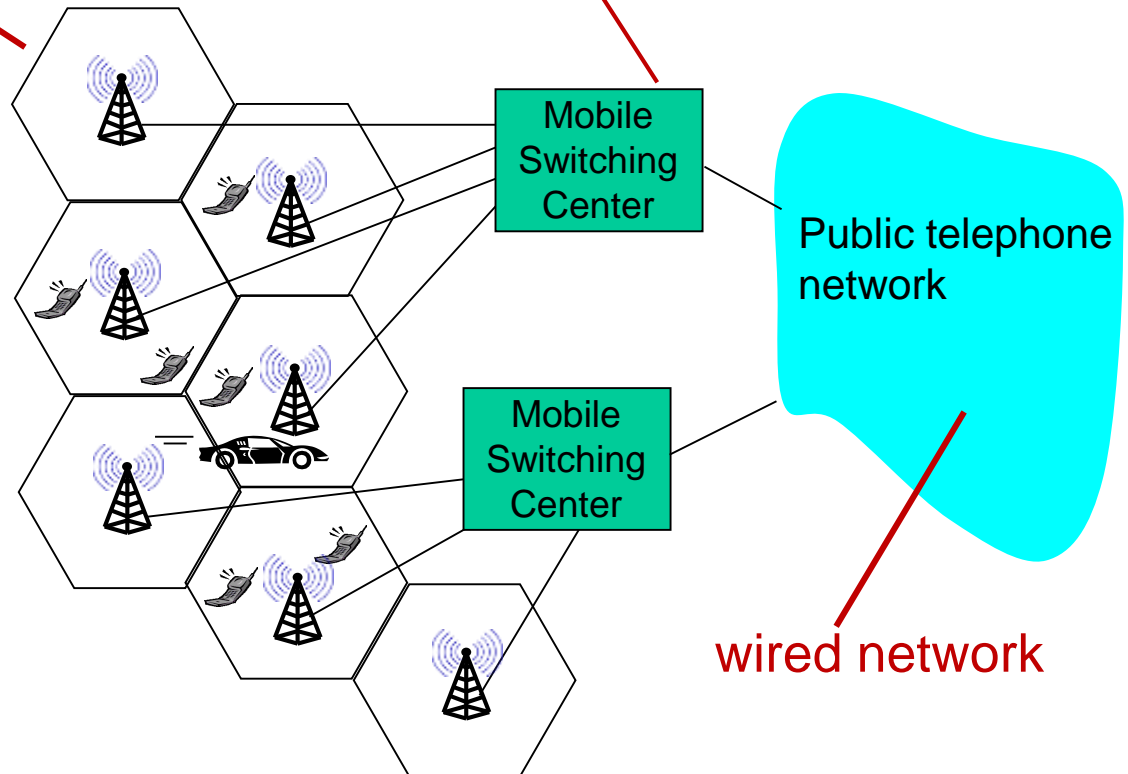

Cellular networks: the first hop

Two techniques for sharing mobile-to-BS radio spectrum

- **combined FDMA/TDMA:** divide spectrum in frequency channels, divide each channel into time slots
- **CDMA:** code division multiple access

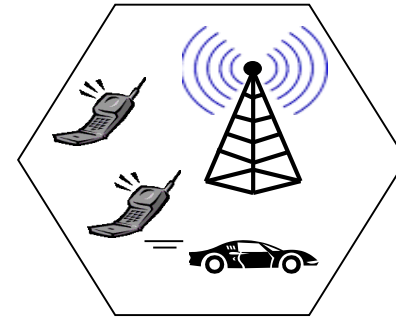

time slots

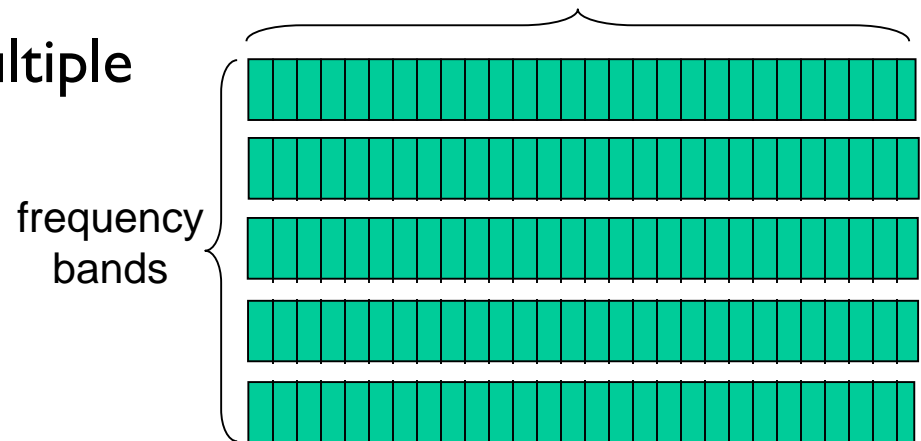

2G (voice) network architecture

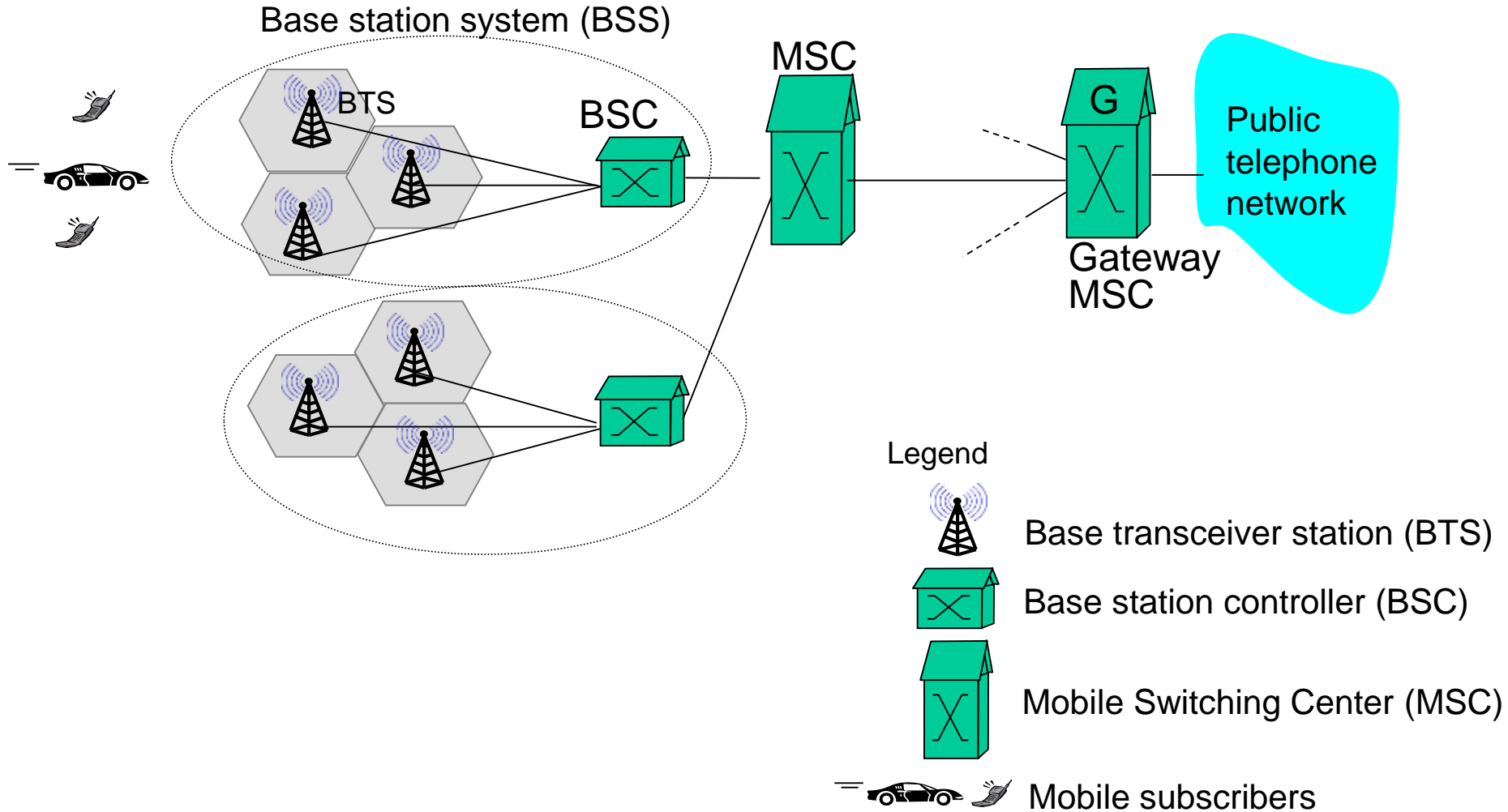

3G (voice+data) network architecture

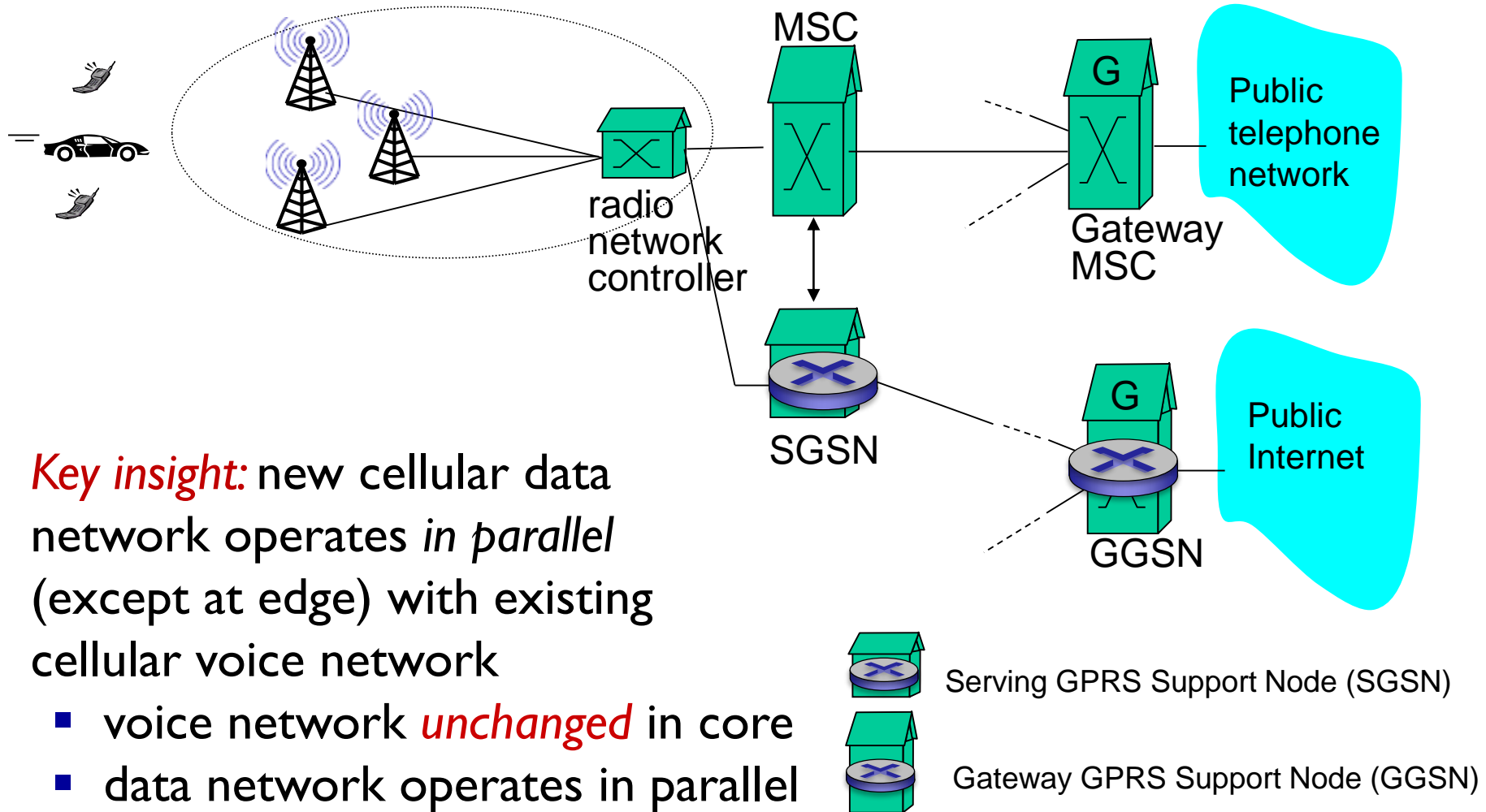

3G (voice+data) network architecture

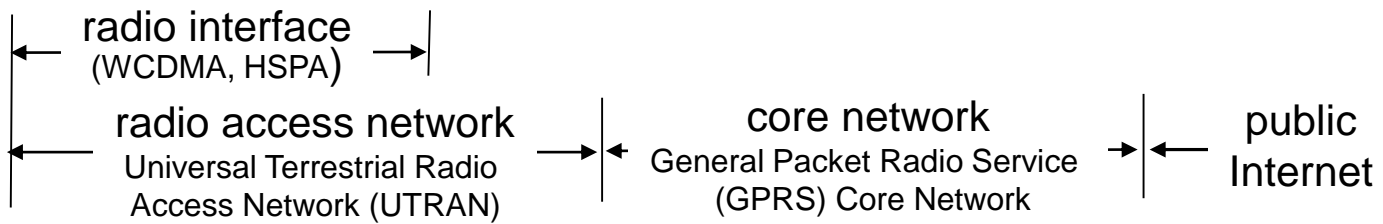
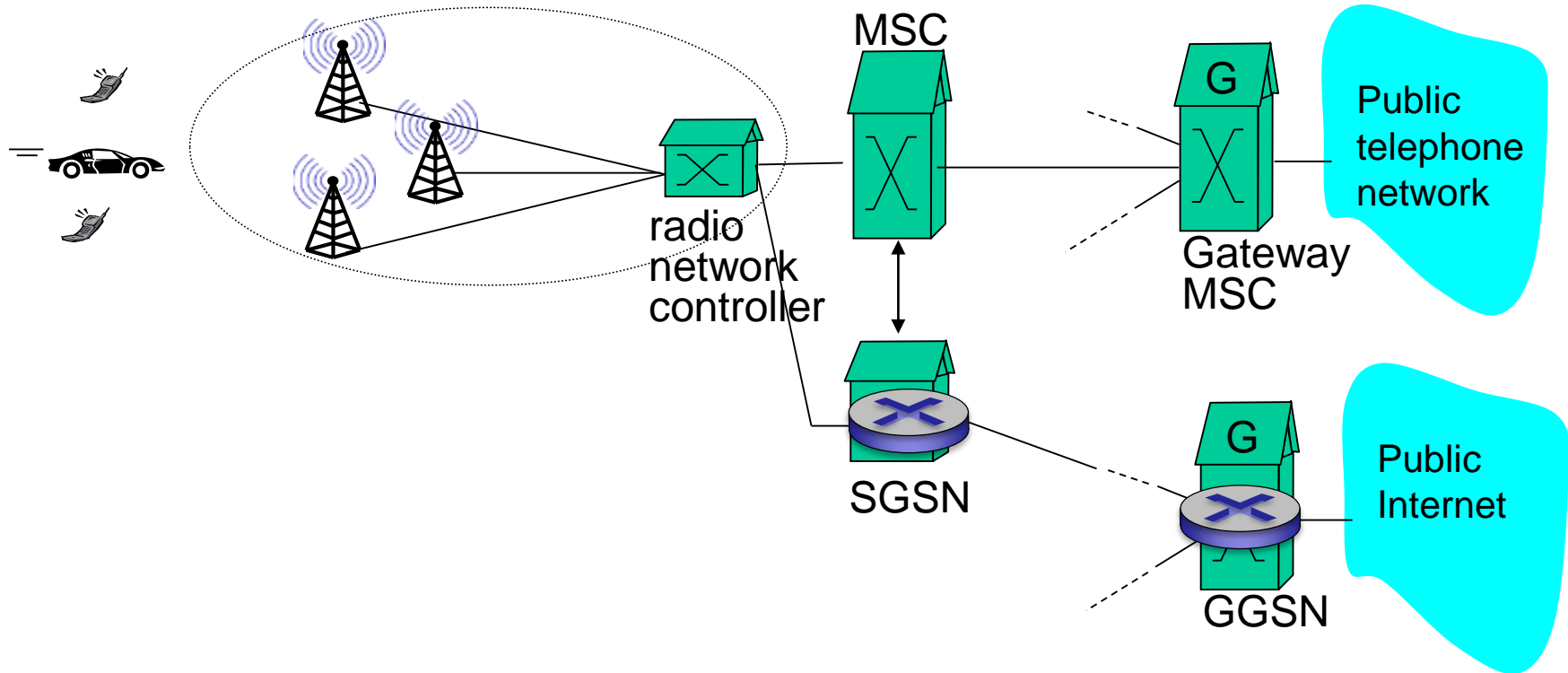

3G versus 4G LTE network architecture

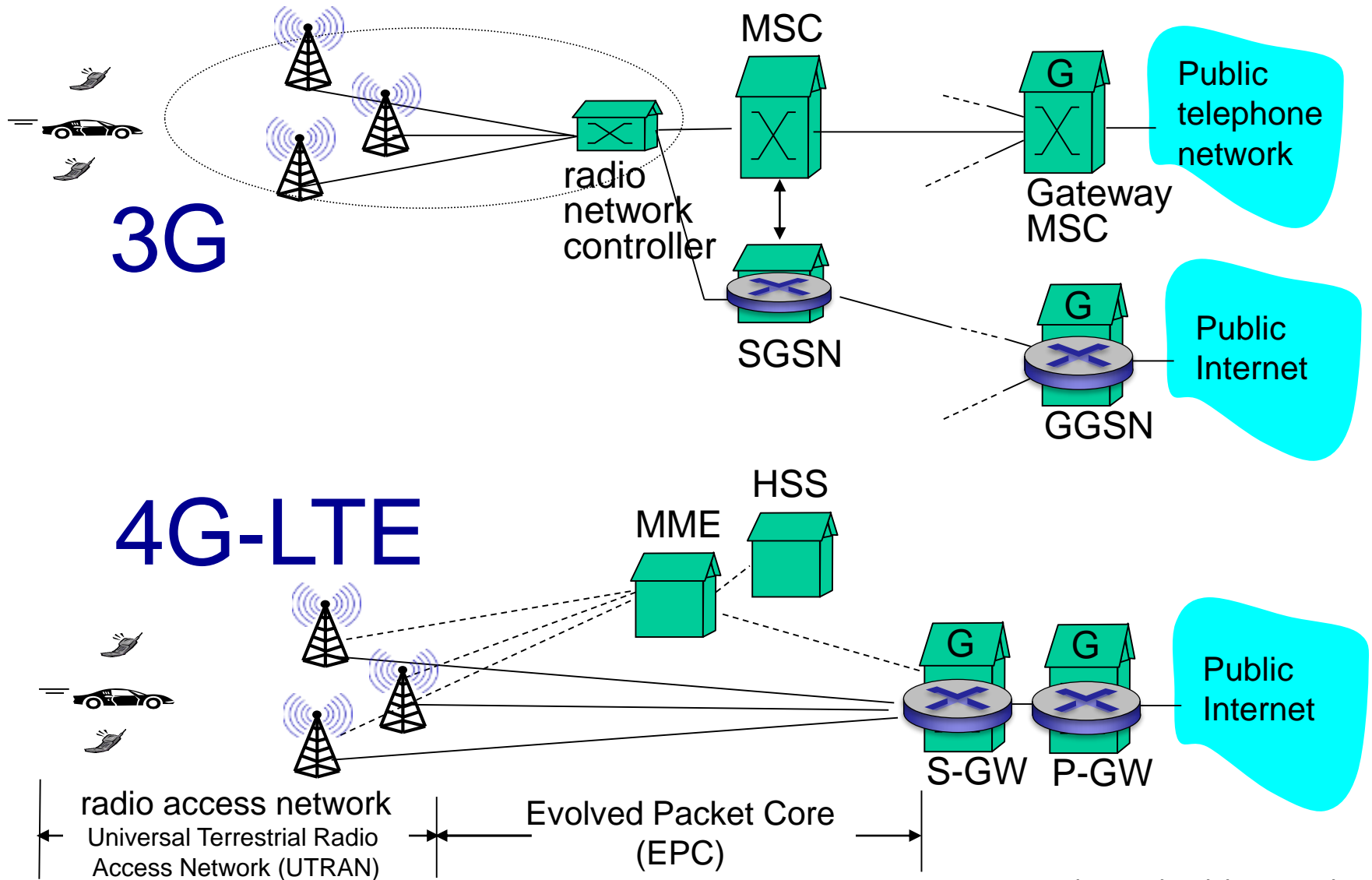

4G: differences from 3G

- all IP core: IP packets tunneled (through core IP network) from base station to gateway
- no separation between voice and data – all traffic carried over IP core to gateway

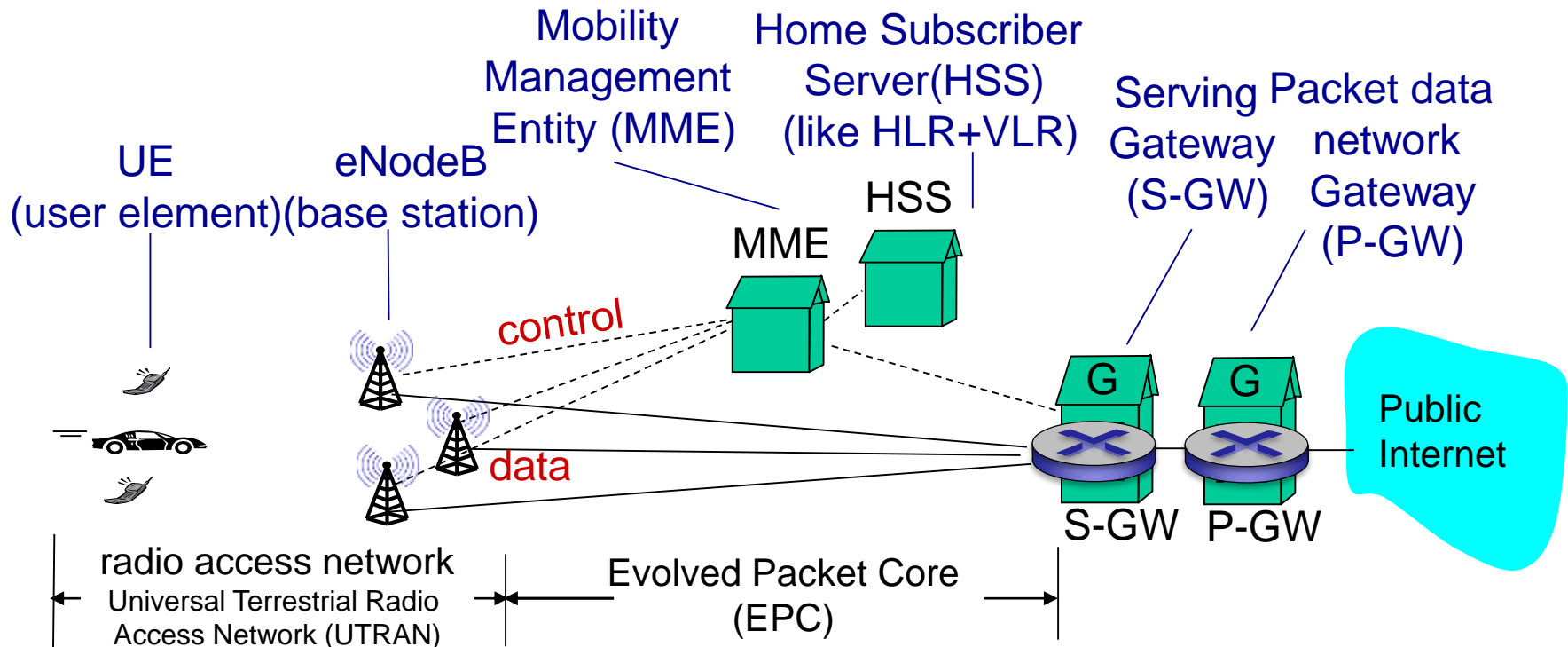

Chapter 7 outline

7.1 Introduction

Wireless

7.2 Wireless links, characteristics

- CDMA

7.3 IEEE 802.11 wireless LANs (“Wi-Fi”)

7.4 Cellular Internet Access

- architecture
- standards (e.g., 3G, LTE)

Mobility

7.5 Principles: addressing and routing to mobile users

7.6 Mobile IP

7.7 Handling mobility in cellular networks

7.8 Mobility and higher-layer protocols

What is mobility?

- spectrum of mobility, from the *network* perspective:

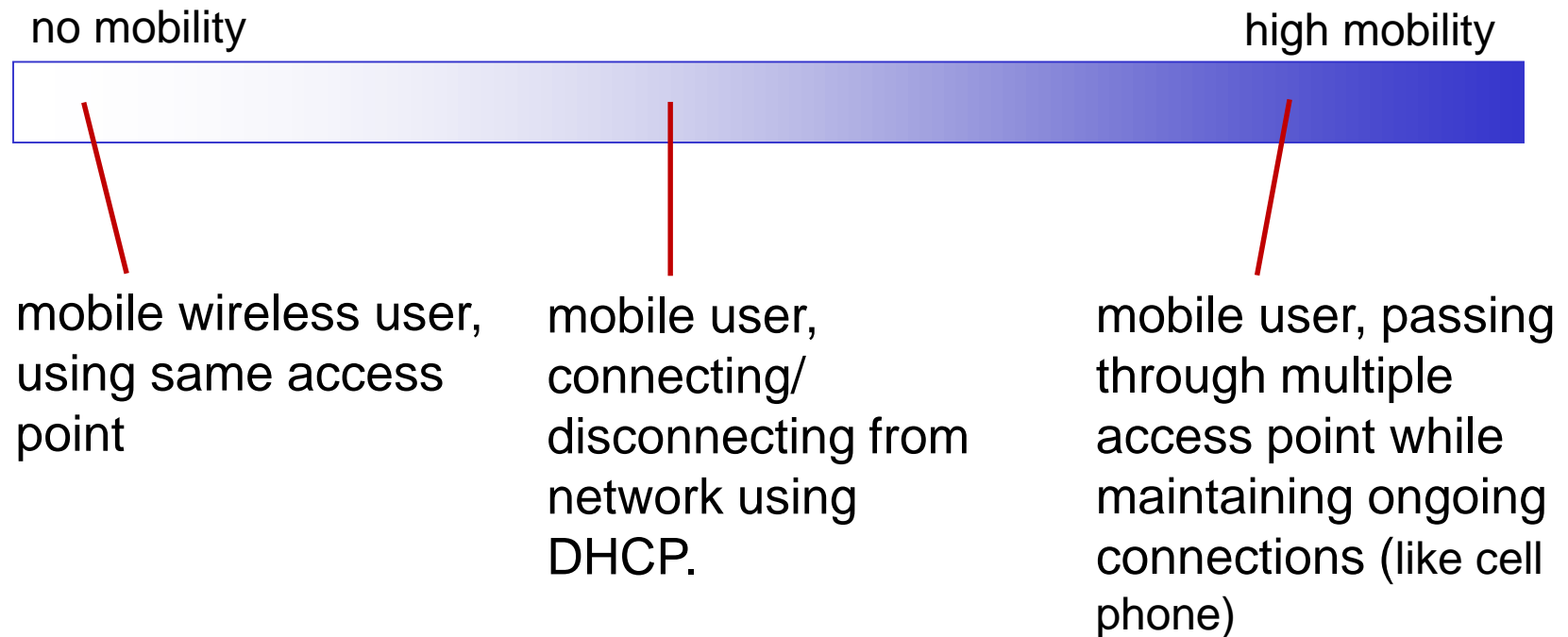

Mobility: vocabulary

home network: permanent
“home” of mobile
(e.g., 128.119.40/24)

home agent: entity that will
perform mobility functions on
behalf of mobile, when mobile is
remote

permanent address:
address in home
network, *can always* be
used to reach mobile
e.g., 128.119.40.186

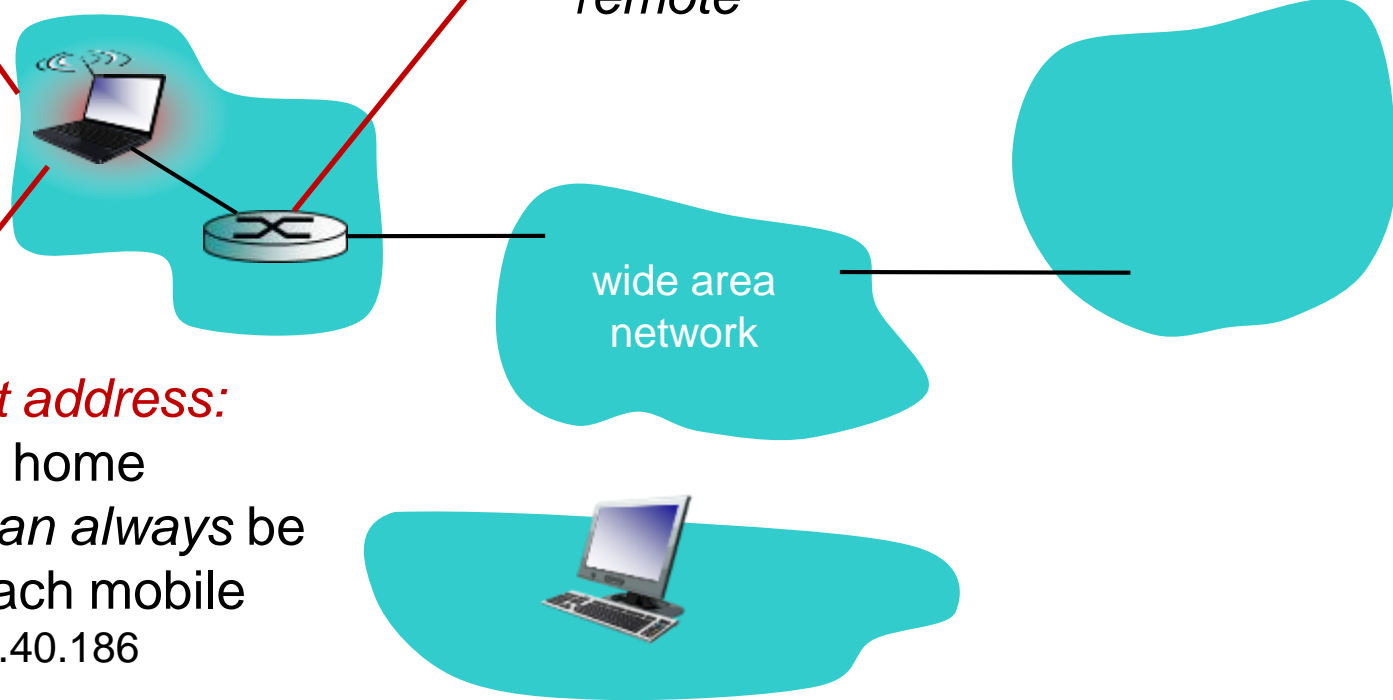

Mobility: more vocabulary

permanent address: remains constant (e.g., 128.119.40.186)

visited network: network in which mobile currently resides (e.g., 79.129.13/24)

care-of-address: address in visited network. (e.g., 79.129.13.2)

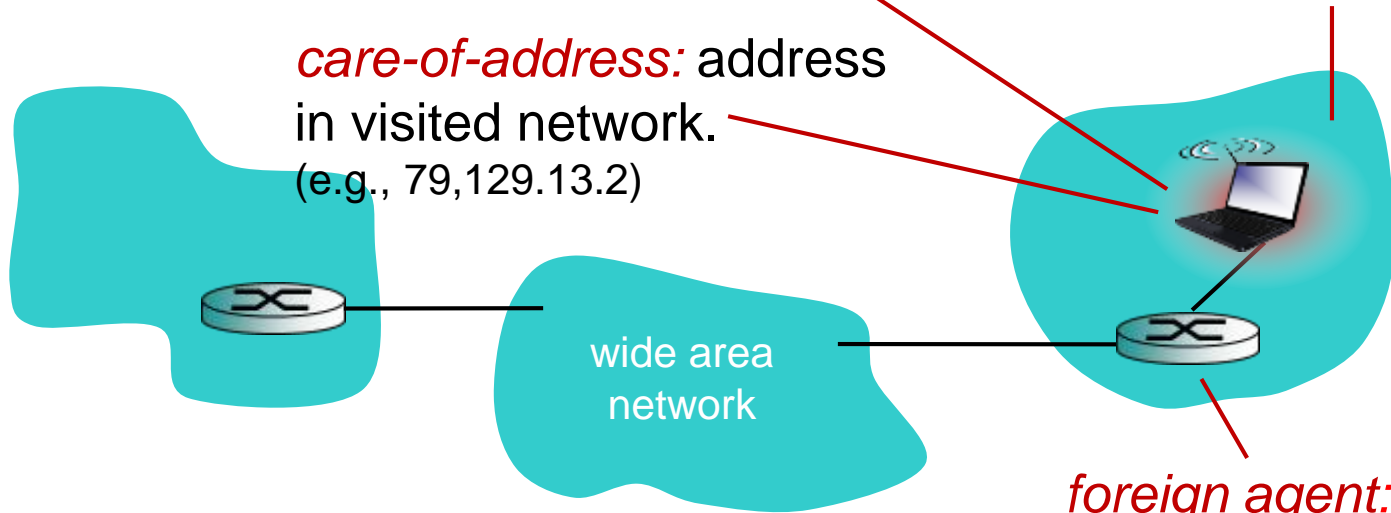

foreign agent: entity in visited network that performs mobility functions on behalf of mobile.

correspondent: wants to communicate with mobile



How do you contact a mobile friend:

Consider friend frequently changing addresses, how do you find her?

- search all phone books?
- call her parents?
- expect her to let you know where he/she is?
- Facebook!

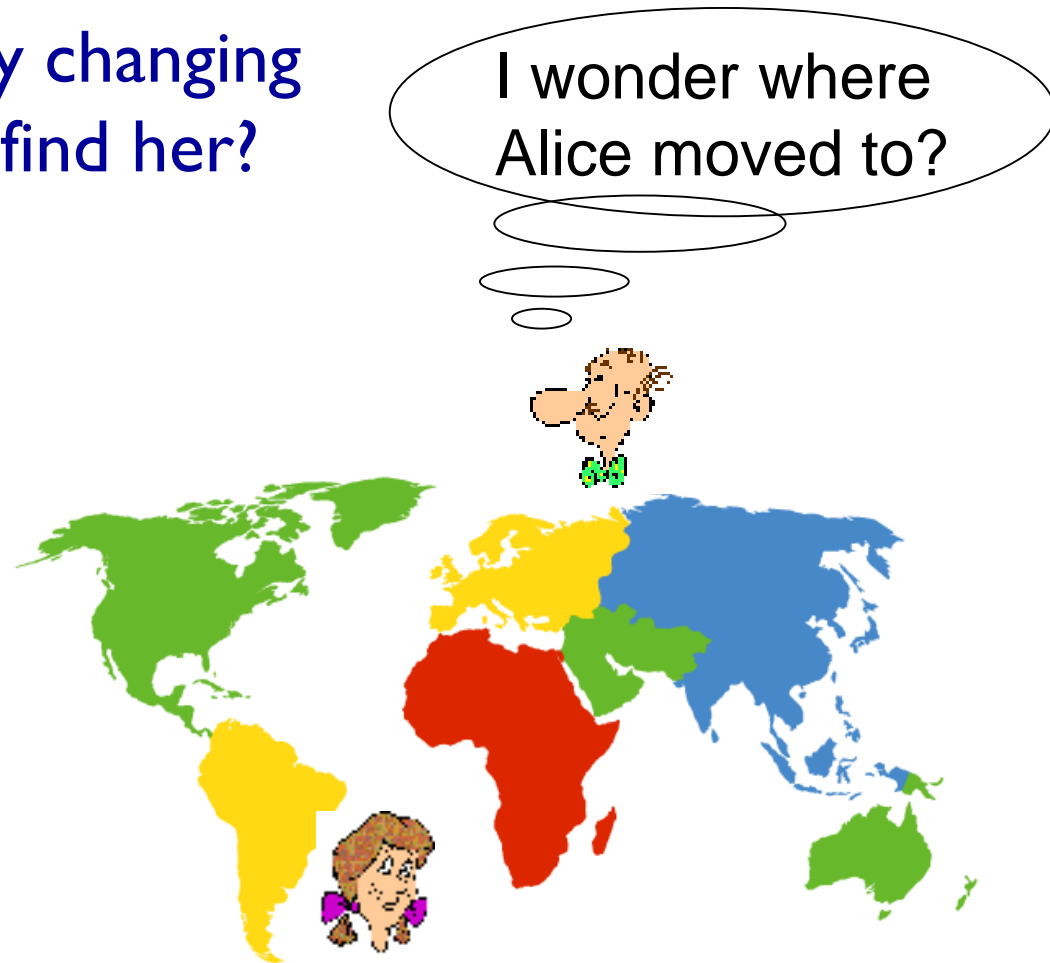

Mobility: approaches

- *let routing handle it:* routers advertise permanent address of mobile-nodes-in-residence via usual routing table exchange.
 - routing tables indicate where each mobile located
 - no changes to end-systems
- *let end-systems handle it:*
 - *indirect routing:* communication from correspondent to mobile goes through home agent, then forwarded to remote
 - *direct routing:* correspondent gets foreign address of mobile, sends directly to mobile

Mobility: approaches

- *let routing handle it:* routers advertise permanent address of mobile, mobile advertises current residence via usual routing table exchange
 - routing table exchange requires one entry for each mobile located
 - no changes to routing table when mobile moves
- *let end-systems handle it:*
 - *indirect routing:* communication from correspondent to mobile goes through home agent, then forwarded to remote
 - *direct routing:* correspondent gets foreign address of mobile, sends directly to mobile

not
scalable
to millions of
mobiles

Mobility: registration

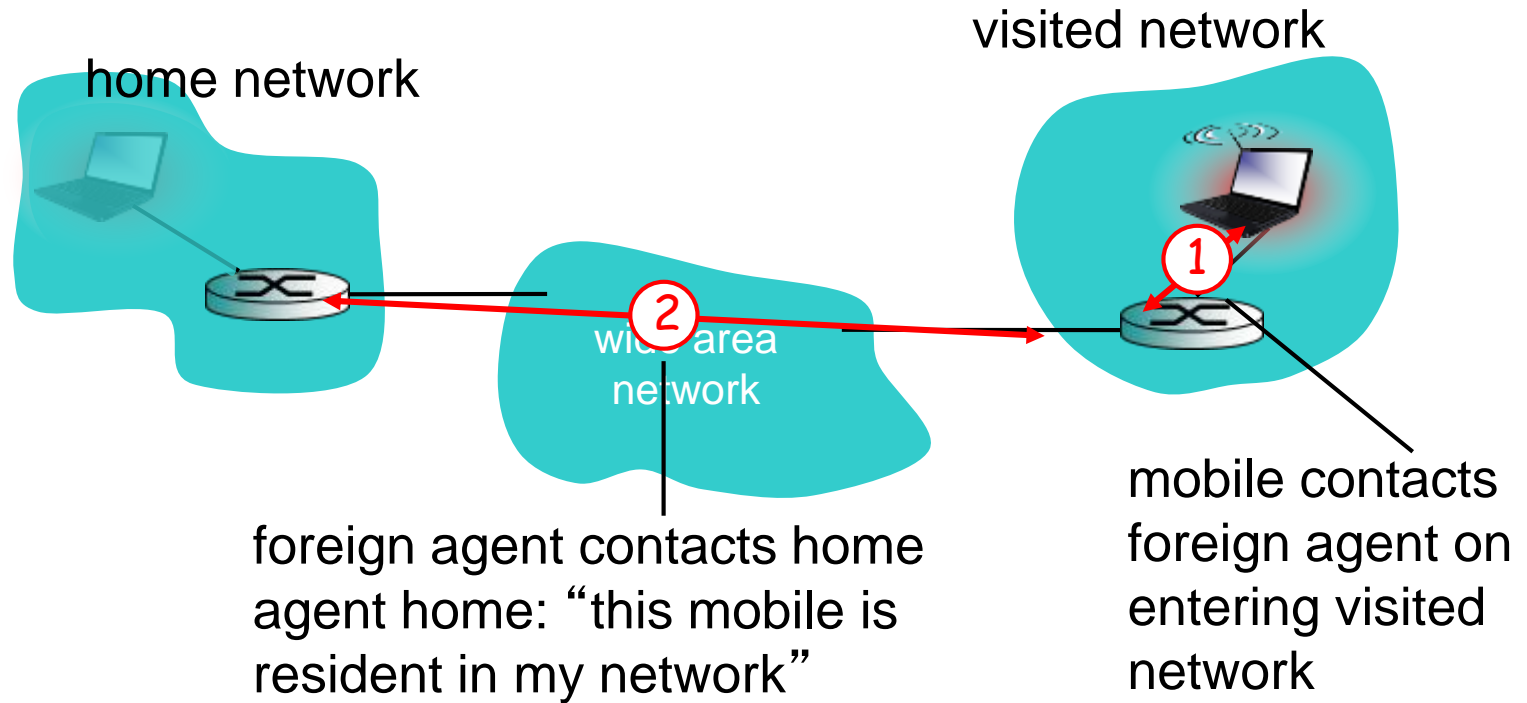

end result:

- foreign agent knows about mobile
- home agent knows location of mobile

Mobility via indirect routing

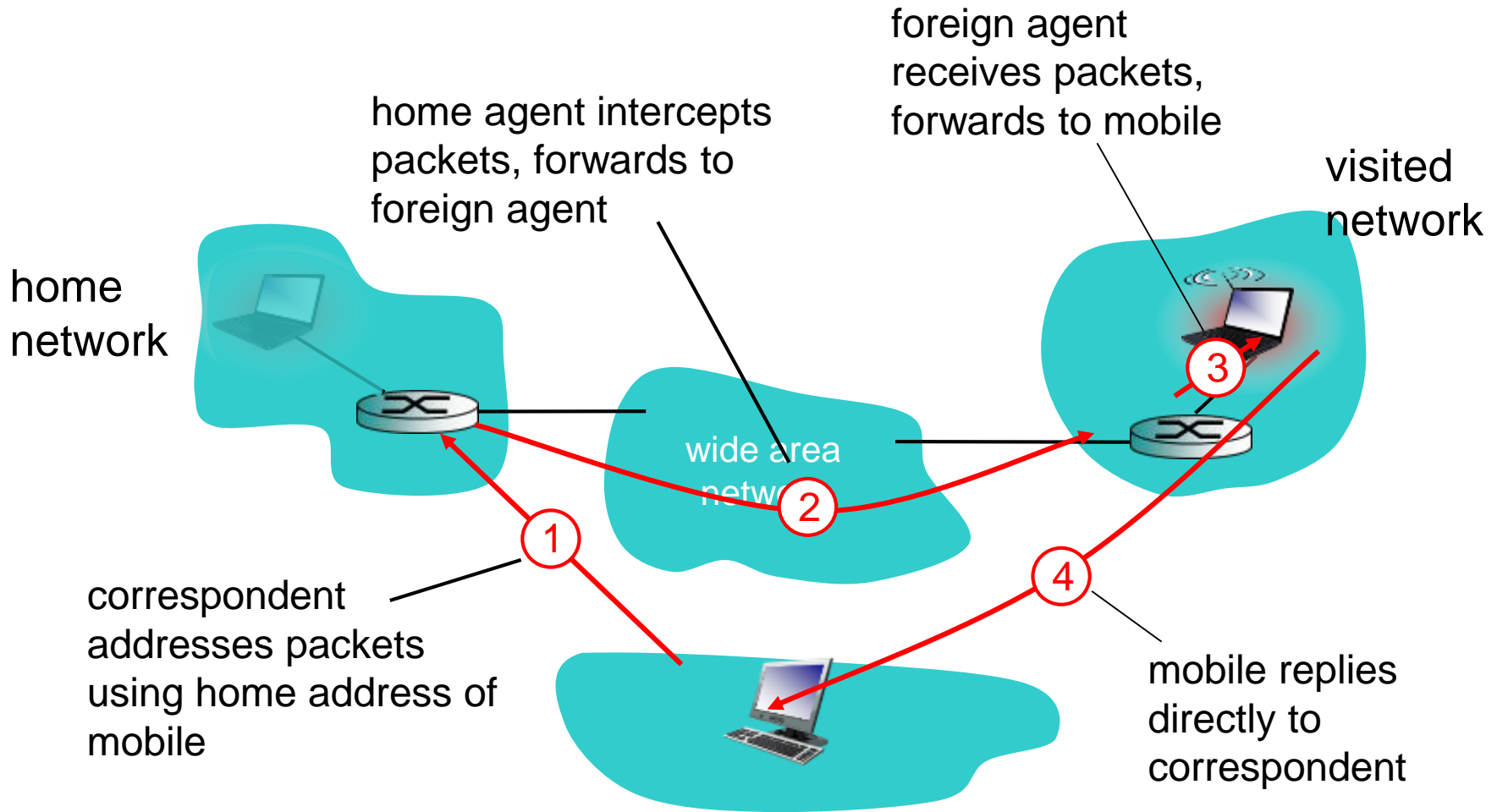

Indirect Routing: comments

- mobile uses two addresses:
 - **permanent address:** used by correspondent (hence mobile location is *transparent* to correspondent)
 - **care-of-address:** used by home agent to forward datagrams to mobile
- foreign agent functions may be done by mobile itself
- **triangle routing:** correspondent-home-network-mobile
 - inefficient when correspondent, mobile are in same network

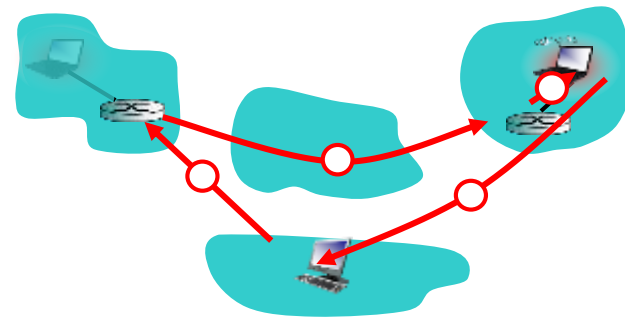

Indirect routing: moving between networks

- suppose mobile user moves to another network
 - registers with new foreign agent
 - new foreign agent registers with home agent
 - home agent update care-of-address for mobile
 - packets continue to be forwarded to mobile (but with new care-of-address)
- mobility, changing foreign networks transparent: *on going connections can be maintained!*

Mobility via direct routing

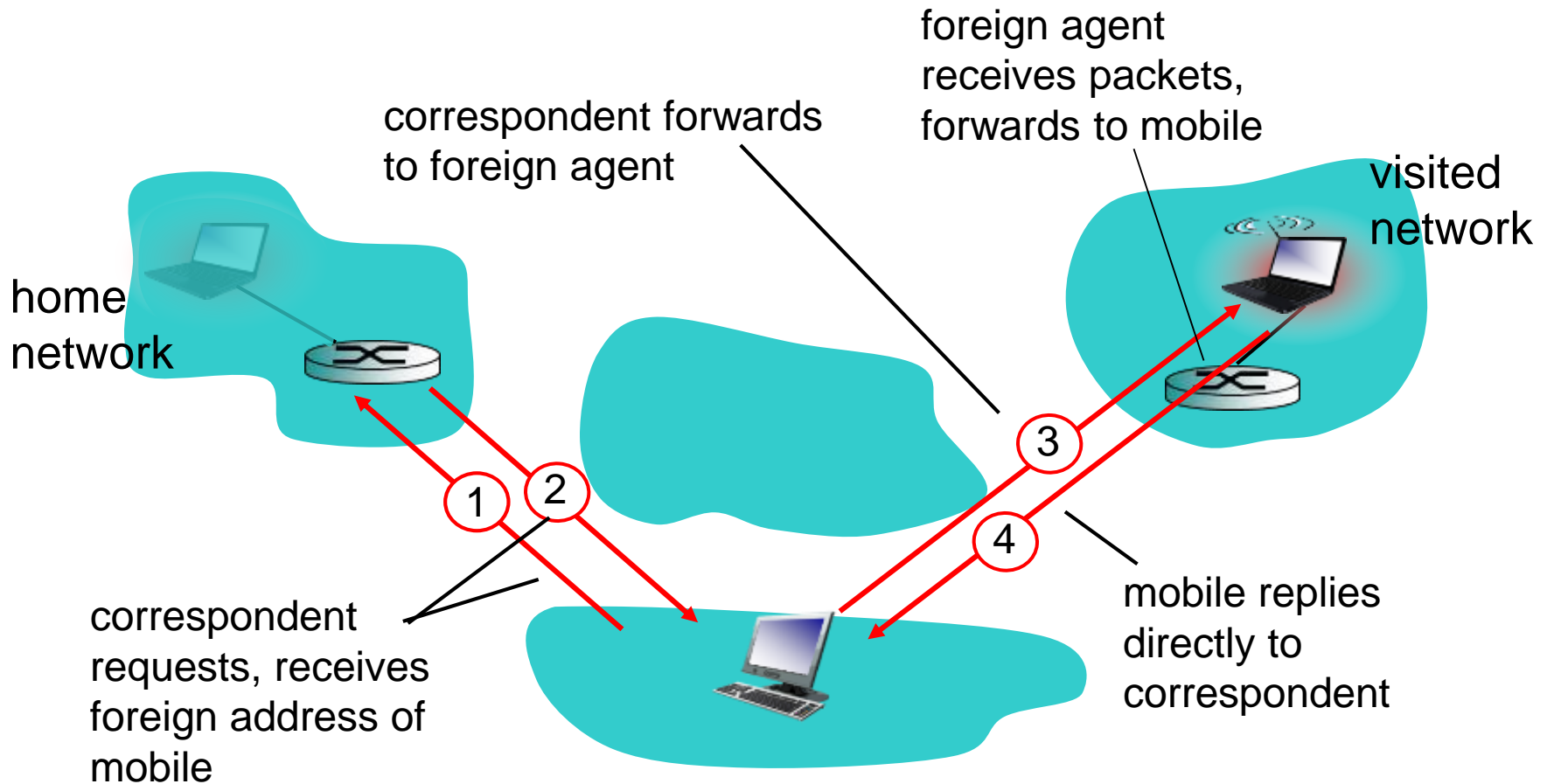

Mobility via direct routing: comments

- overcome triangle routing problem
- *non-transparent to correspondent*: correspondent must get care-of-address from home agent
 - what if mobile changes visited network?

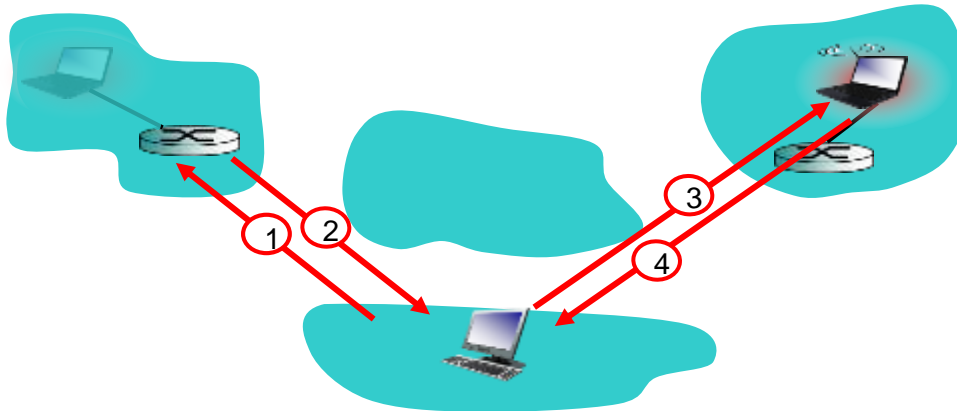

Accommodating mobility with direct routing

- anchor foreign agent: FA in first visited network
- data always routed first to anchor FA
- when mobile moves: new FA arranges to have data forwarded from old FA (chaining)

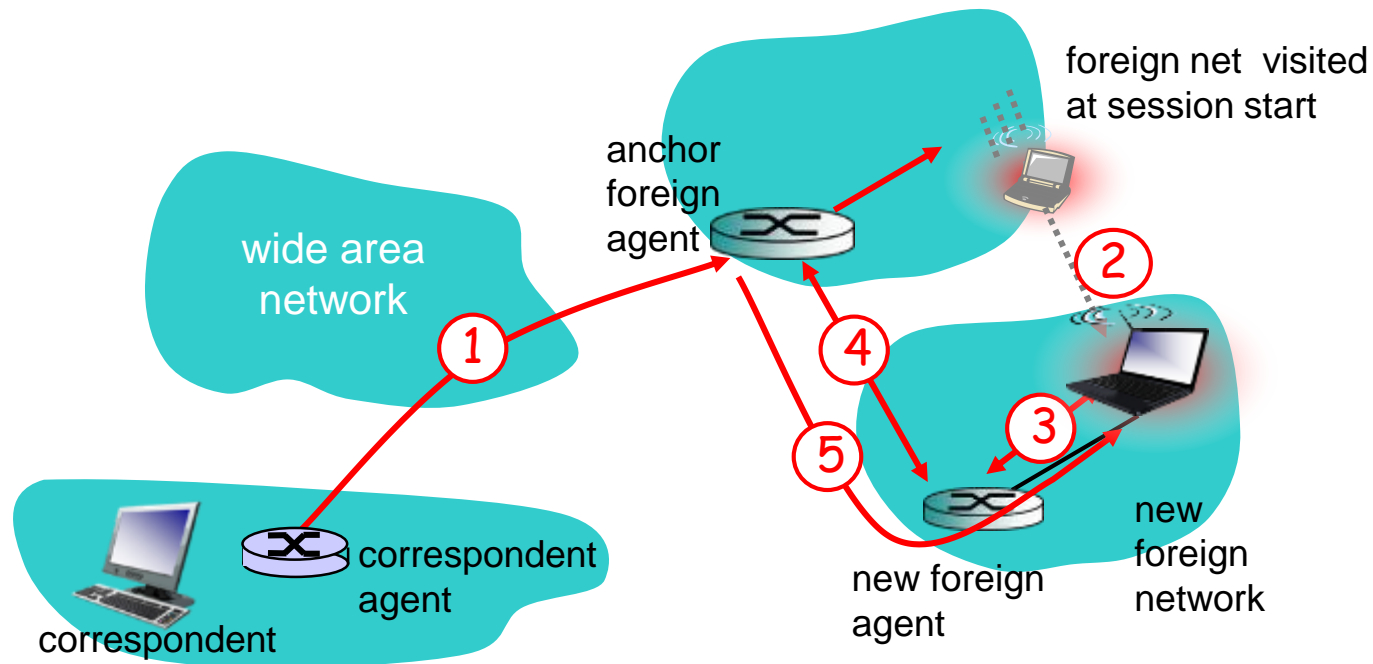

Chapter 7 outline

7.1 Introduction

Wireless

7.2 Wireless links, characteristics

- CDMA

7.3 IEEE 802.11 wireless LANs (“Wi-Fi”)

7.4 Cellular Internet Access

- architecture
- standards (e.g., 3G, LTE)

Mobility

7.5 Principles: addressing and routing to mobile users

7.6 Mobile IP

7.7 Handling mobility in cellular networks

7.8 Mobility and higher-layer protocols

Mobile IP

- RFC 3344
- has many features we've seen:
 - home agents, foreign agents, foreign-agent registration, care-of-addresses, encapsulation (packet-within-a-packet)
- three components to standard:
 - indirect routing of datagrams
 - agent discovery
 - registration with home agent

Mobile IP: indirect routing

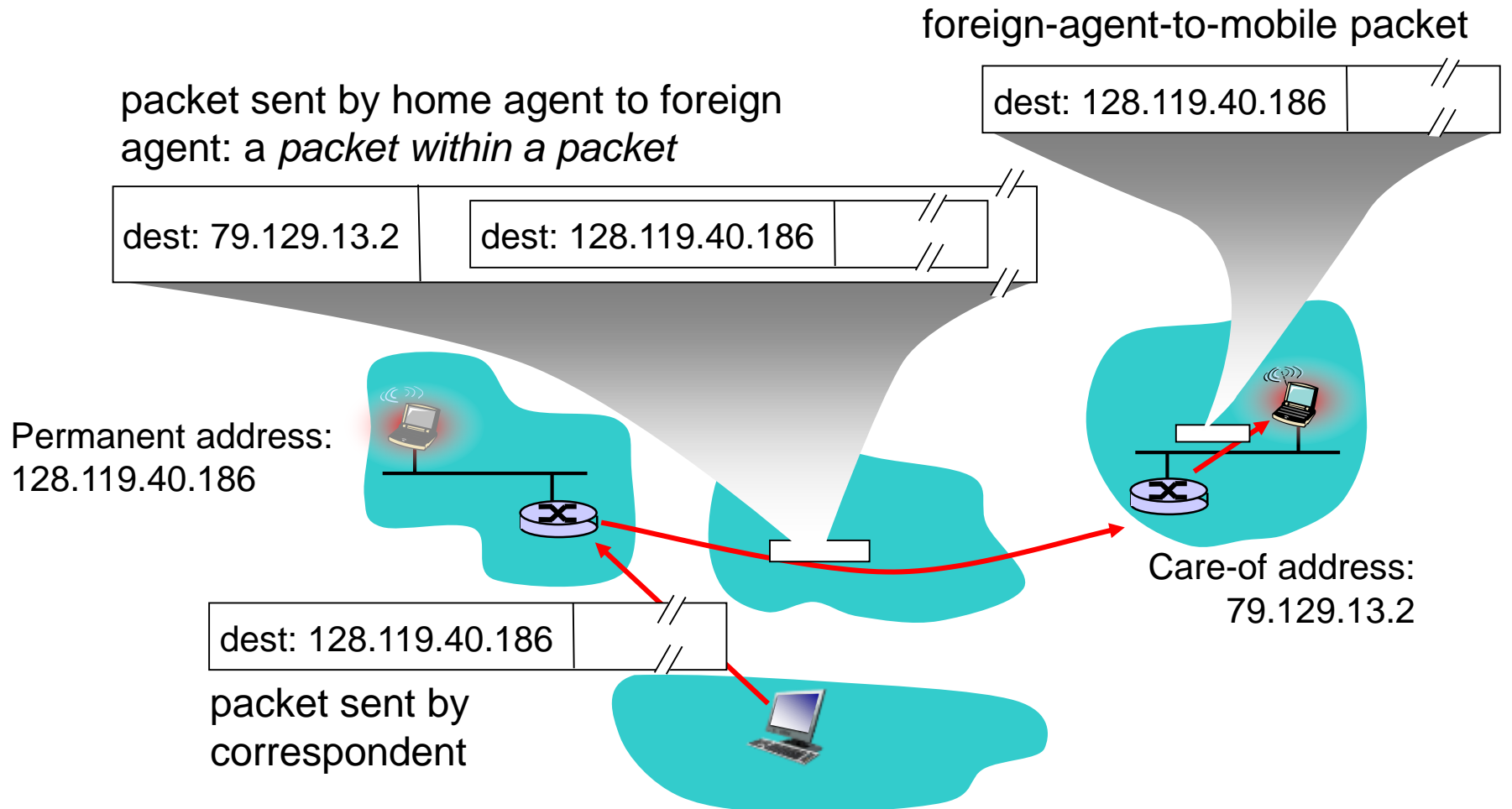

Mobile IP: agent discovery

- *agent advertisement*: foreign/home agents advertise service by broadcasting ICMP messages (typefield = 9)

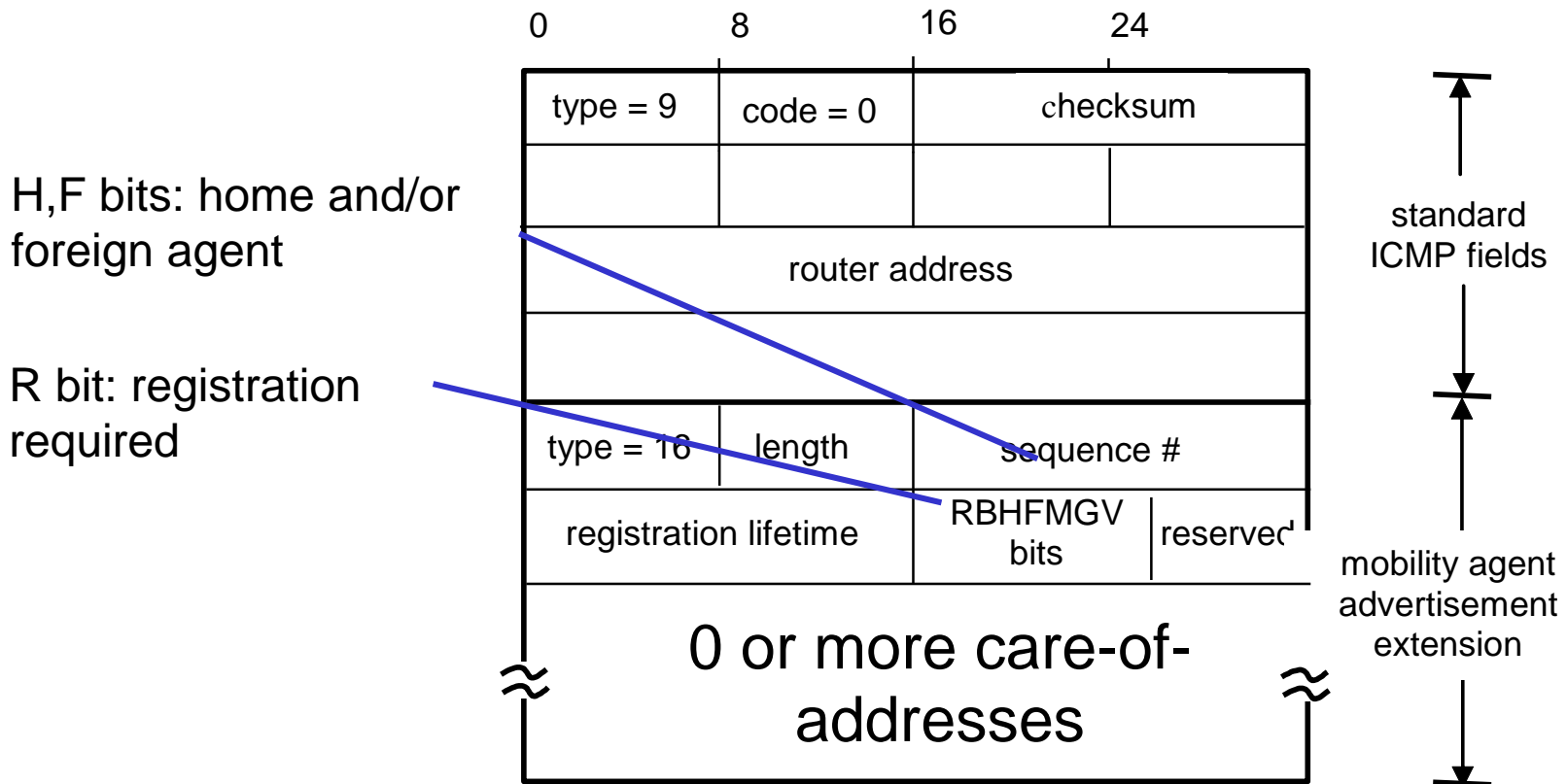

Mobile IP: registration example

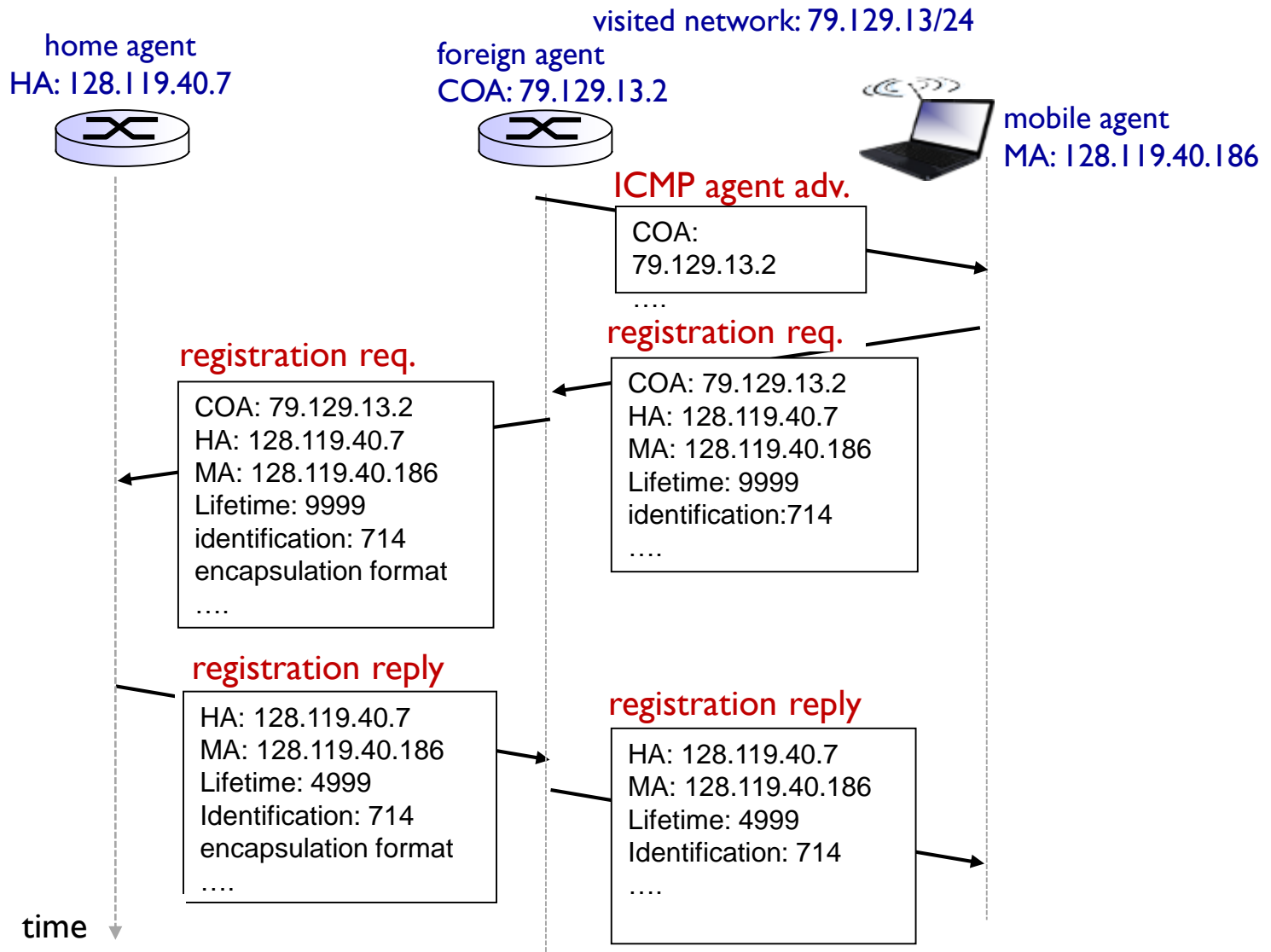

Components of cellular network architecture

recall:

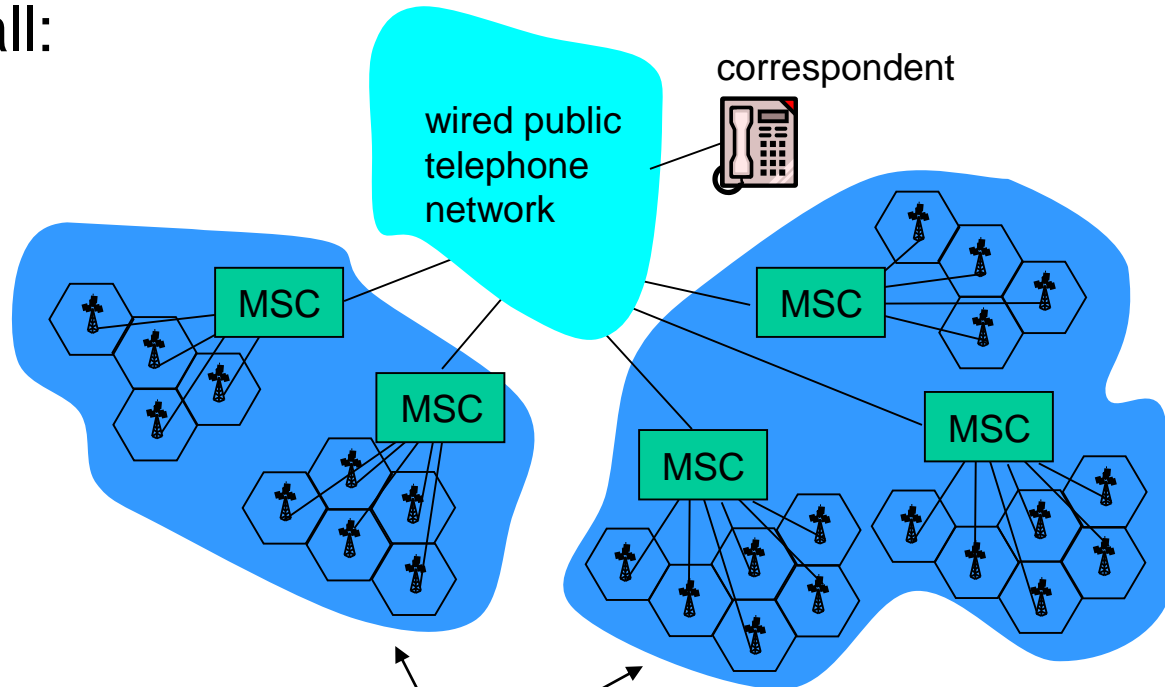

different cellular networks,
operated by different providers

Handling mobility in cellular networks

- **home network:** network of cellular provider you subscribe to (e.g., Sprint PCS, Verizon)
 - **home location register (HLR):** database in home network containing permanent cell phone #, profile information (services, preferences, billing), information about current location (could be in another network)
- **visited network:** network in which mobile currently resides
 - **visitor location register (VLR):** database with entry for each user currently in network
 - could be home network

GSM: indirect routing to mobile

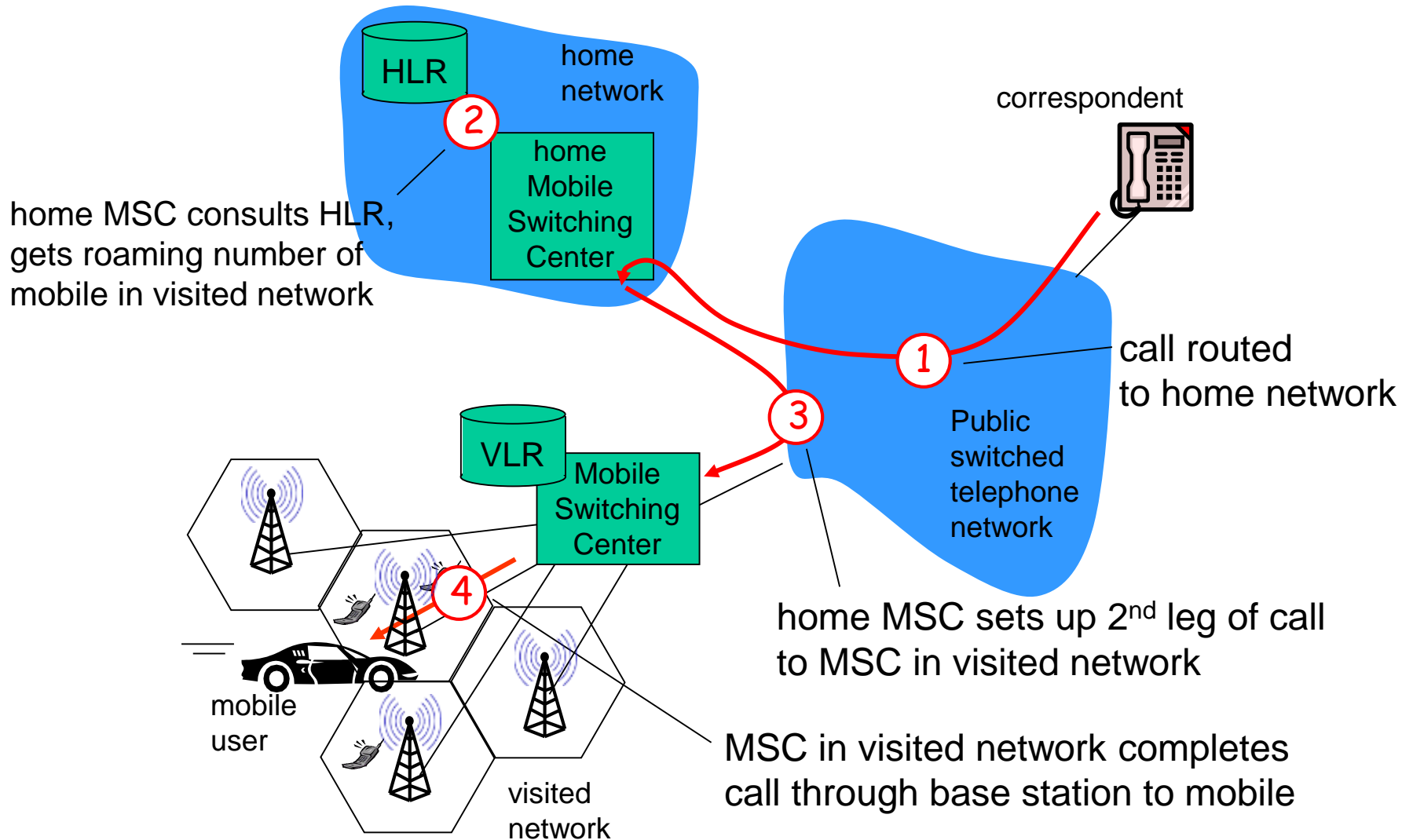

GSM: handoff with common MSC

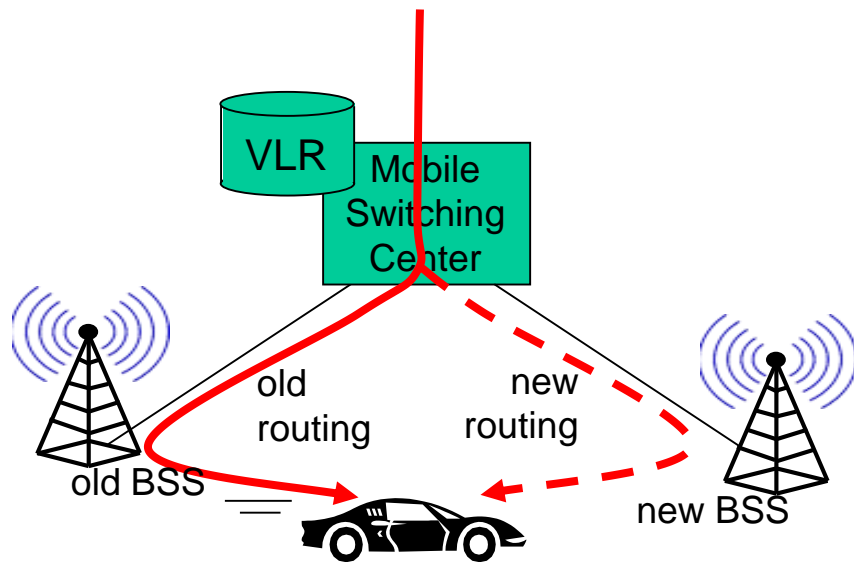

- *handoff goal*: route call via new base station (without interruption)
- reasons for handoff:
 - stronger signal to/from new BSS (continuing connectivity, less battery drain)
 - load balance: free up channel in current BSS
 - GSM doesn't mandate why to perform handoff (policy), only how (mechanism)
- handoff initiated by old BSS

GSM: handoff with common MSC

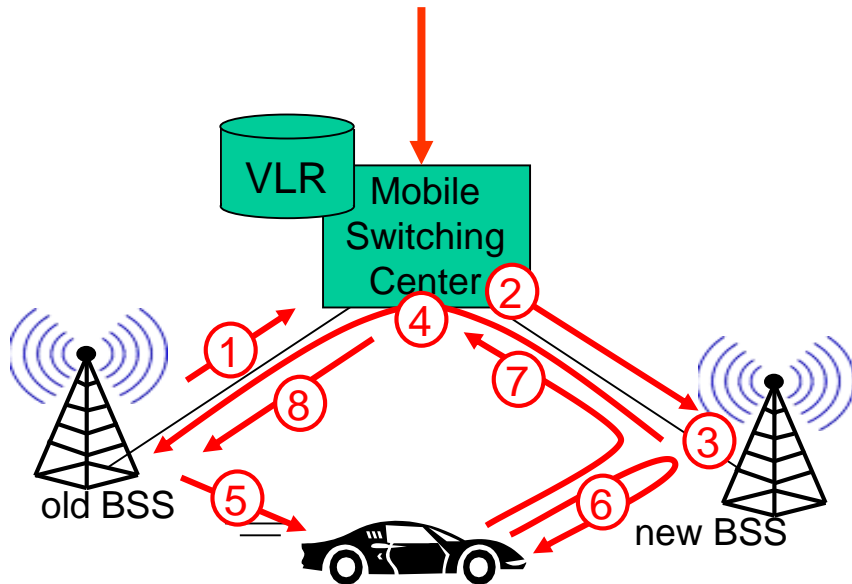

1. old BSS informs MSC of impending handoff, provides list of 1+ new BSSs
2. MSC sets up path (allocates resources) to new BSS
3. new BSS allocates radio channel for use by mobile
4. new BSS signals MSC, old BSS: ready
5. old BSS tells mobile: perform handoff to new BSS
6. mobile, new BSS signal to activate new channel
7. mobile signals via new BSS to MSC: handoff complete. MSC reroutes call
8. MSC-old-BSS resources released

GSM: handoff between MSCs

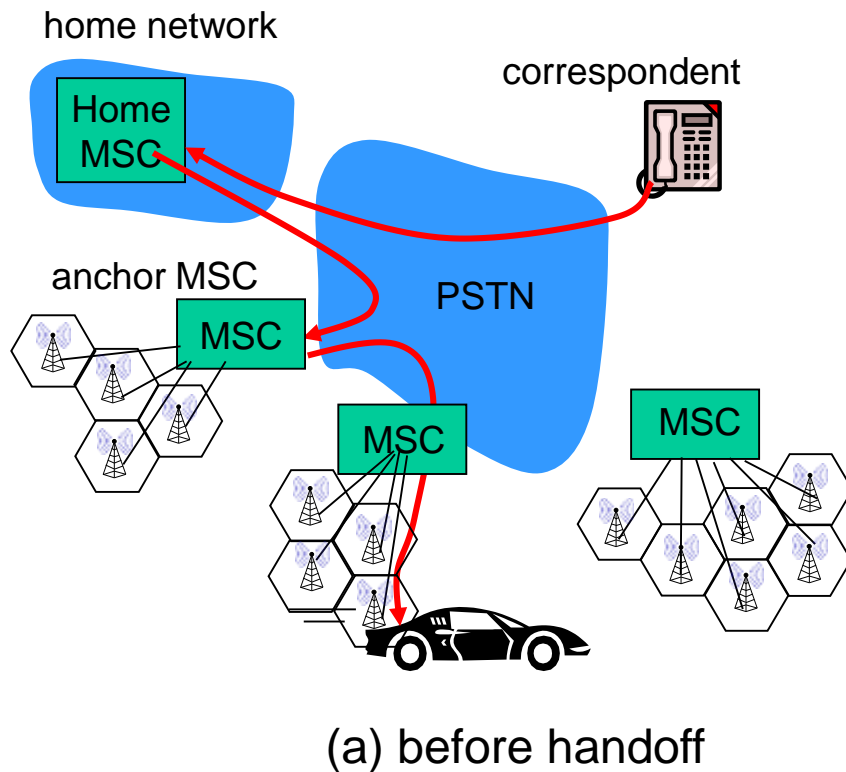

- *anchor MSC*: first MSC visited during call
 - call remains routed through anchor MSC
- new MSCs add on to end of MSC chain as mobile moves to new MSC
- optional path minimization step to shorten multi-MSC chain

GSM: handoff between MSCs

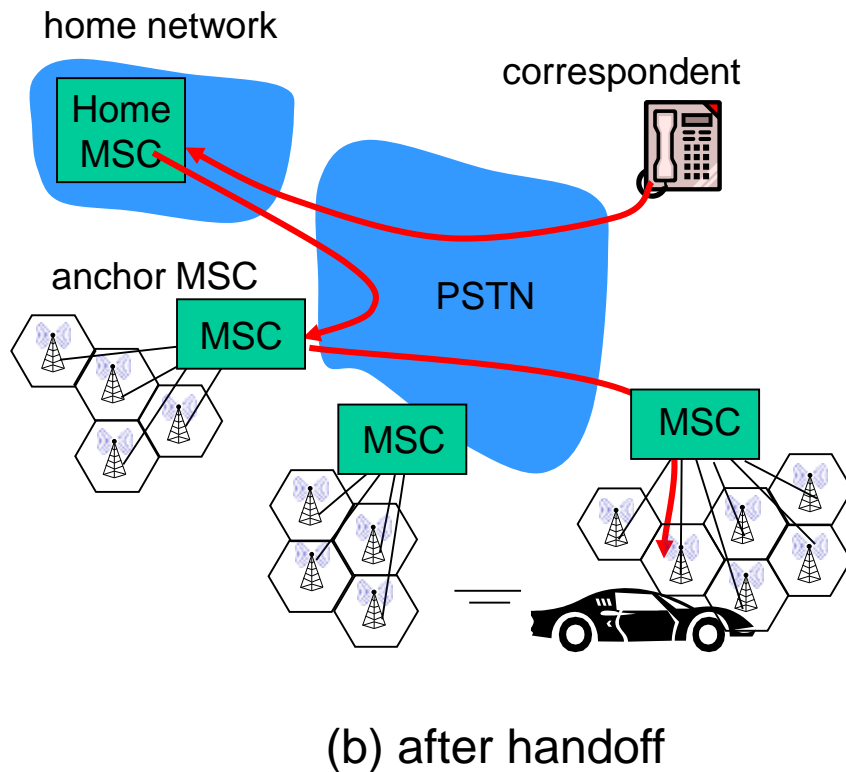

- *anchor MSC*: first MSC visited during call
 - call remains routed through anchor MSC
- new MSCs add on to end of MSC chain as mobile moves to new MSC
- optional path minimization step to shorten multi-MSC chain

Handling Mobility in LTE

- Paging: idle UE may move from cell to cell: network does not know where the idle UE is resident
 - paging message from MME broadcast by all eNodeB to locate UE

- handoff: similar to 3G:

- preparation phase
- execution phase
- completion phase

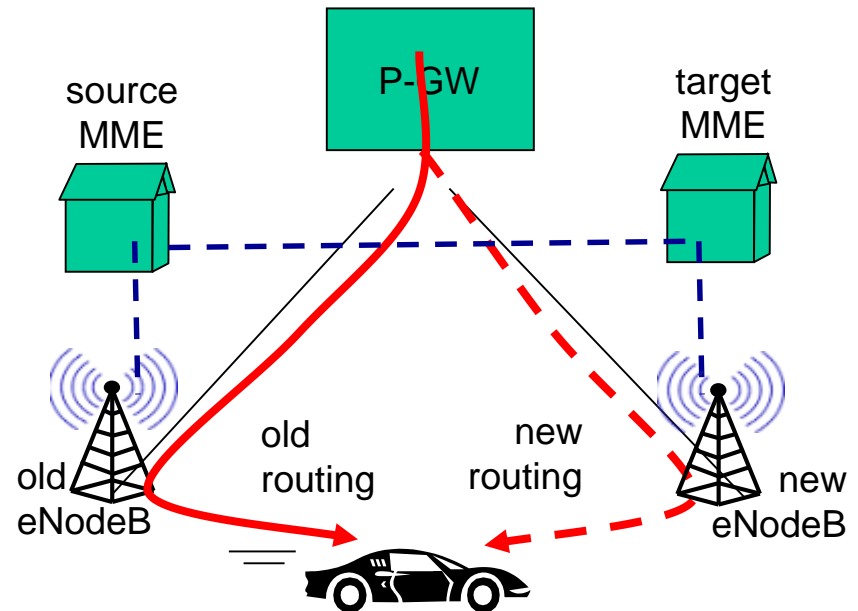

Mobility: cellular versus Mobile IP

cellular element	Comment on cellular element	Mobile IP element
Home system	Network to which mobile user's permanent phone number belongs	Home network
Gateway Mobile Switching Center, or "home MSC". Home Location Register (HLR)	Home MSC: point of contact to obtain routable address of mobile user. HLR: database in home system containing permanent phone number, profile information, current location of mobile user, subscription information	Home agent
Visited System	Network other than home system where mobile user is currently residing	Visited network
Visited Mobile services Switching Center. Visitor Location Register (VLR)	Visited MSC: responsible for setting up calls to/from mobile nodes in cells associated with MSC. VLR: temporary database entry in visited system, containing subscription information for each visiting mobile user	Foreign agent
Mobile Station Roaming Number (MSRN), or "roaming number"	Routable address for telephone call segment between home MSC and visited MSC, visible to neither the mobile nor the correspondent.	Care-of-address

Wireless, mobility: impact on higher layer protocols

- logically, impact *should* be minimal ...
 - best effort service model remains unchanged
 - TCP and UDP can (and do) run over wireless, mobile
- ... but performance-wise:
 - packet loss/delay due to bit-errors (discarded packets, delays for link-layer retransmissions), and handoff
 - TCP interprets loss as congestion, will decrease congestion window un-necessarily
 - delay impairments for real-time traffic
 - limited bandwidth of wireless links

Chapter 7 summary

Wireless

- wireless links:
 - capacity, distance
 - channel impairments
 - CDMA
- IEEE 802.11 (“Wi-Fi”)
 - CSMA/CA reflects wireless channel characteristics
- cellular access
 - architecture
 - standards (e.g., 3G, 4G LTE)

Mobility

- principles: addressing, routing to mobile users
 - home, visited networks
 - direct, indirect routing
 - care-of-addresses
- case studies
 - mobile IP
 - mobility in GSM, LTE
- impact on higher-layer protocols