

# Wireless Evolution

---



# Mobile Evolution

1G	2G	3G	4G	5G
1981	1992	2001	2010	2019
2 Kbps	64 Kbps	2 Mbps	100 Mbps	10 Gbps
Basic voice service using analog protocols	Designed primarily for voice using the digital standards (GSM/CDMA)	First mobile broadband utilizing IP protocols (WCDMA / CDMA2000)	True mobile broadband on a unified standard (LTE)	'Tactile Internet' with service-aware devices and fiber-like speeds
 <p>Analogue</p>	 <p>Digital</p>	 <p>Mobile broadband</p>	 <p>Mobile internet (PS only)</p> <p>Mobile internet explosion fueled by Ux revolution</p>	
				

# Mobile Evolution

## 2G

Voice+SMS

Feature Phone

14.4~64Kbps

GSM

CDMA

## 3G

Voice(→ mVoIP) + SMS/MMS(→ Mobile Chatting)  
 영상전화 + Internet  
 + Applications

Camera Phone → Smart Phone/Mobile Tablet PC

3G(2Mbps)

WCDMA

cdma2000  
/1x EV-DO

3.5G(14.4Mbps)

HSDPA/  
HSUPA

1x EV-DO  
Rev. A/B

3.9G(128Mbps)

HSPA+

LTE

## 4G

3G +  
High Quality  
Multi-Media

Smart Device

LTE-Adv.  
(600Mbps↑)

IEEE  
802.16m  
(600Mbps↑)

WiBro  
Wave1  
(19.8Mbps)

WiBro  
Wave2  
(34.4Mbps)

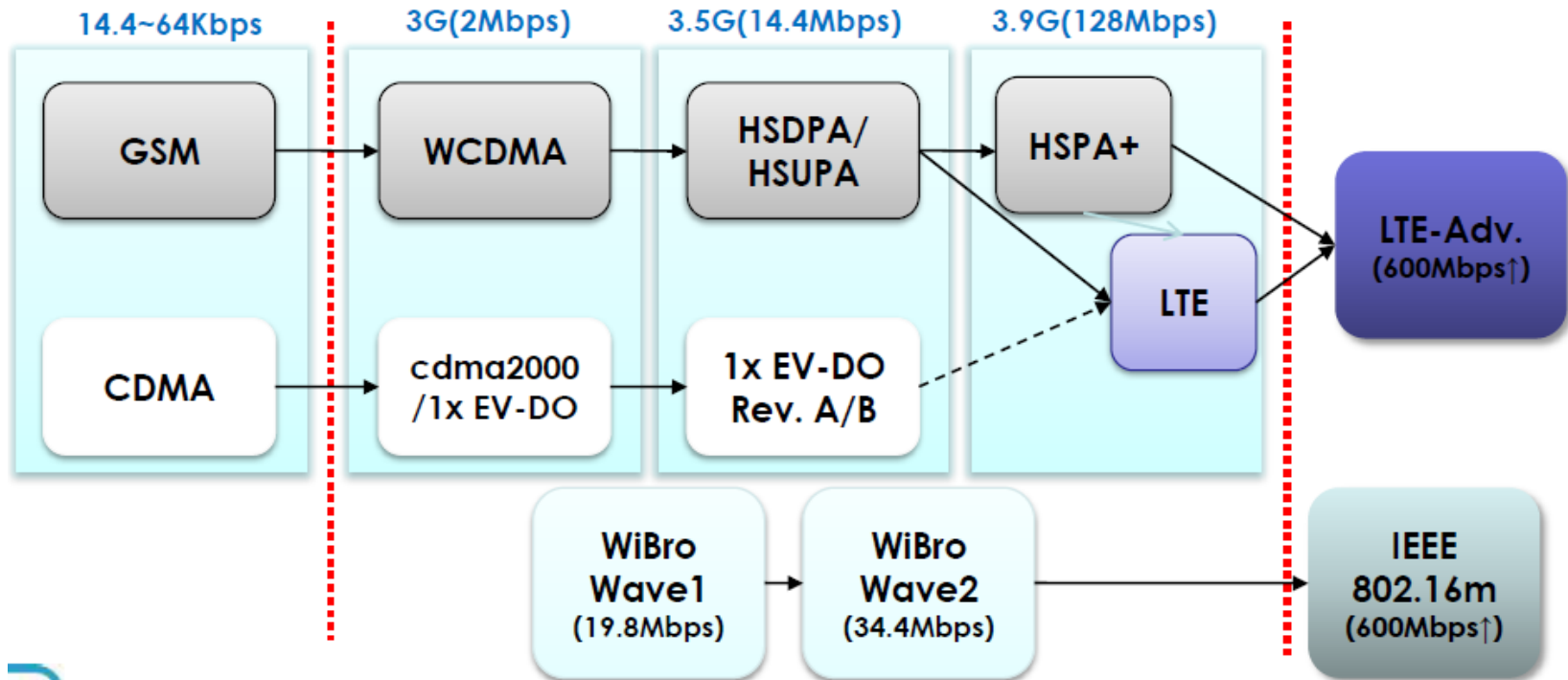

# 이동통신 세대별 서비스 진화

- 음성 → 단순문자 서비스 → 모바일 인터넷기반 서비스  
→ 융합 서비스

	1G	2G	3G	3.5G	>3.9G
음성 통화	아날로그 음성	디지털 음성 (8Kbps)	디지털 음성(8Kbps)	고품질(23Kbps)	회선기반 음성 패킷기반 mVolp
영상 통화	-	-	일반(64Kbps)	고품질(384Kbps)	
문자서비스	-	SMS	SMS/MMS	모바일 채팅(SNS)	
로밍	-	-	지동 로밍	+SIM 로밍	
엔터테인먼트	-	제한된 콘텐츠	콘텐츠 확대 (일부 앱스토어 활용)	다양한 콘텐츠 (앱스토어 활용 증가)	
위치기반	-	기지국 수준	2G+일부 GPS 수준	GPS 수준	
전자상거래	-	조회 수준	뱅킹/증권거래		
유무선 통신 융합 서비스	-	단순 결합 상품	다양한 유무선 융합 서비스 제공		
방송 통신 융합 서비스	-	-	m-IPTV	m-IPTV + 개인/기업 방송	
산업간 융합 서비스	-	저속 M2M	다양한 M2M	다양한 M2M + 융합 서비스	

# 이동통신 세대별 서비스 진화

- 채널 대역폭: 협대역 → 광대역
- 다중 액세스: 회선기반의 CDMA (협대역 → 광대역) → 패킷기반의 OFDMA
- 변조방식: BPSK/QPSK → 8PSK/16QAM → 64QAM
- 다중안테나; 단일 셀 기반 기술(다이버시티 → MIMO 다중화 → Single Cell MU-MIMO) → 다중 셀 기반 기술(Multi-cell MU-MIMO, CoMP, ICIC etc.)

	CDMA		WCDMA		LTE			WiBo		
	EvDo Rev.A	EvDo Rev.B	HSDPA	HSPA+ (Rel.7)	Rel.8	Rel.9	Rel.10	Rel. 1.0		Rel. 2.0
								Wave 1	Wave 2	
다중접속	CDMA (협대역 → 광대역)				OFDMA/SC-FDMA			OFDMA		
Duplexing	FDD		FDD/TDD			TDD		FDD/TDD		
대역폭	1.25	1.25x3	5		1.4/3/5/10/20/40			10	10	5/10/20
변조방식	QPSK/8PSK /16QAM		16QAM	~16QAM	~64QAM					
MIMO	Diversity			2x2 MIMO	2x2 MIMO	4x4 MIMO	Diversity	2x2 MIMO	4x4 MIMO	
최대전송 속도(Mbps)	3.1 1.8	9.3 5.4	14.4 5.76	28 11.5	73.4 36.6	293.7 146.7	19.97 5.04	37.44 10.08	350 200	
음성 전송	회선기반 음성				패킷기반 mVoIP					

# Mobile Technology Evolution in Standard (1/2)

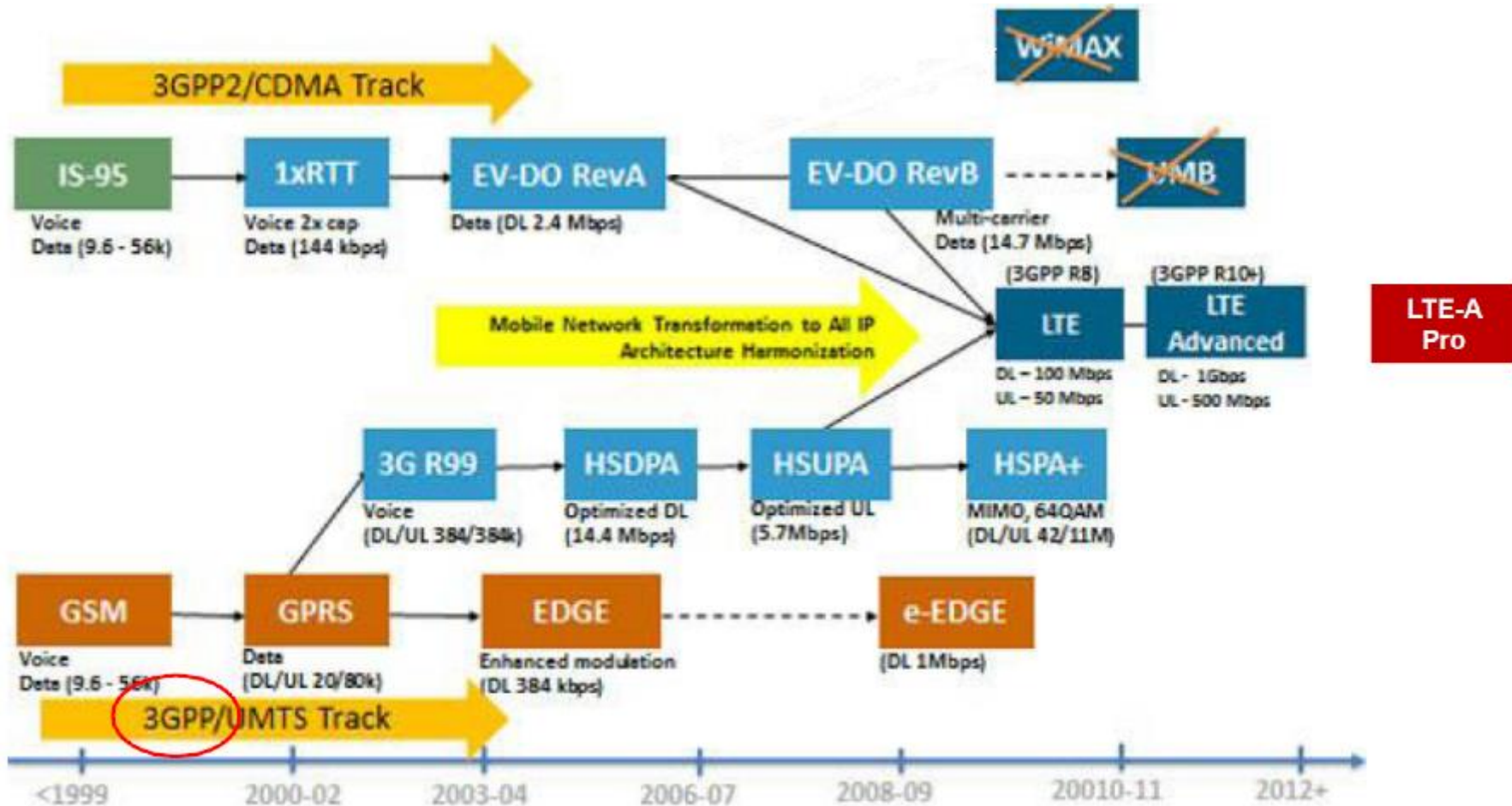

\* DL/UL speed is as per specifications, however actual speed depend upon many factors.

# Mobile Technology Evolution in Standard (2/2)

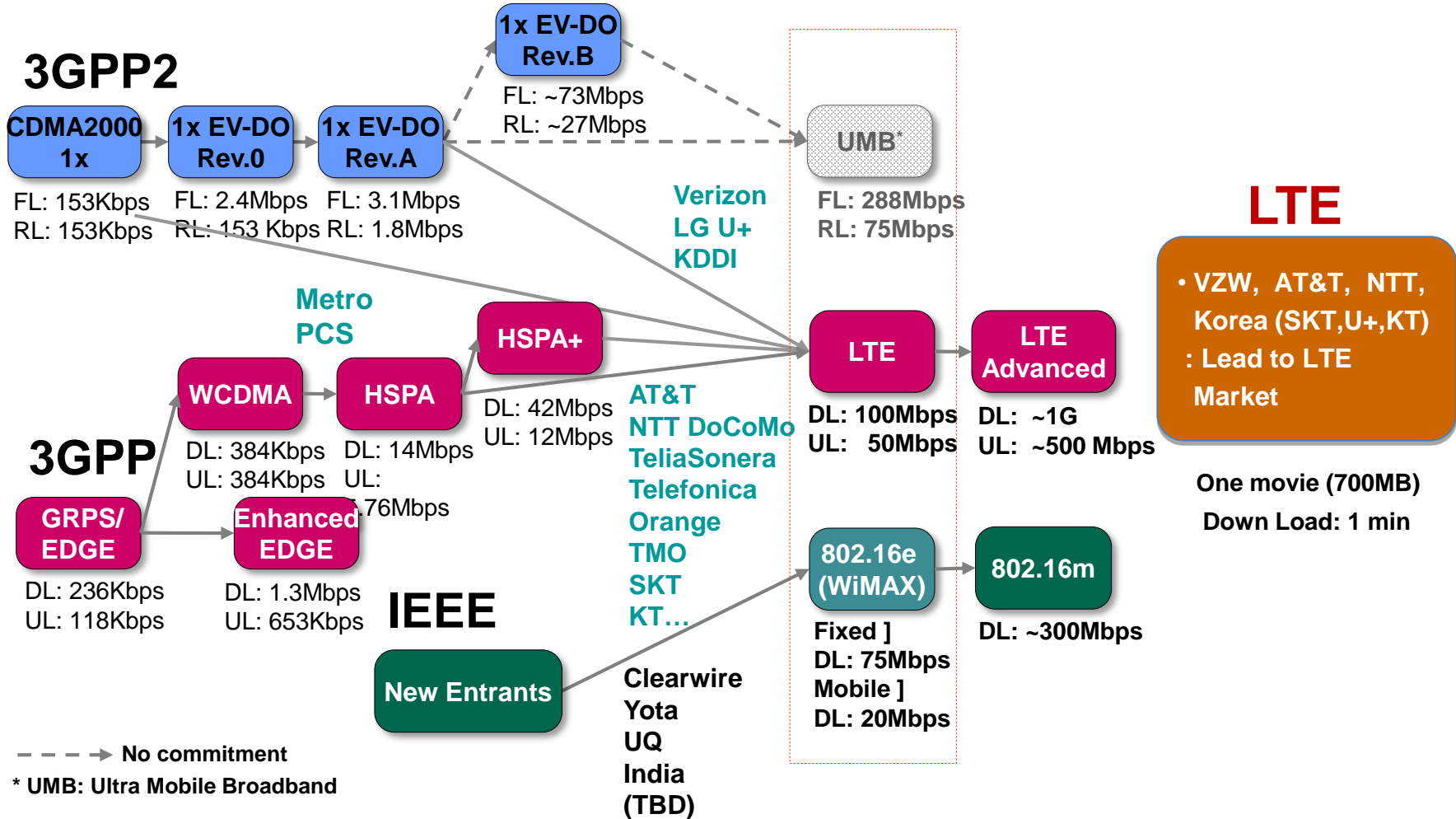

# 3GPP Evolution

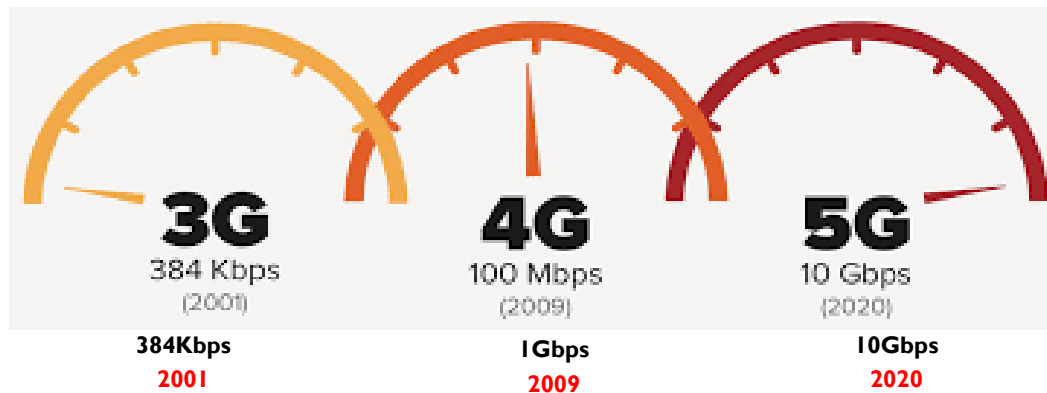
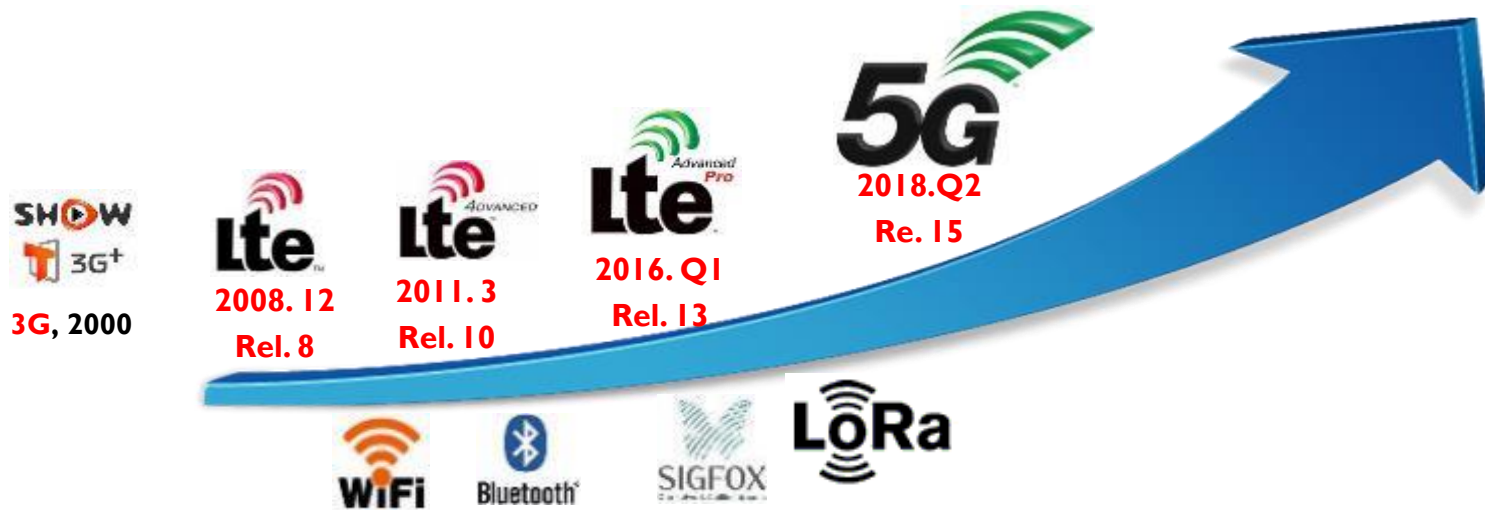



# 5G commercialization

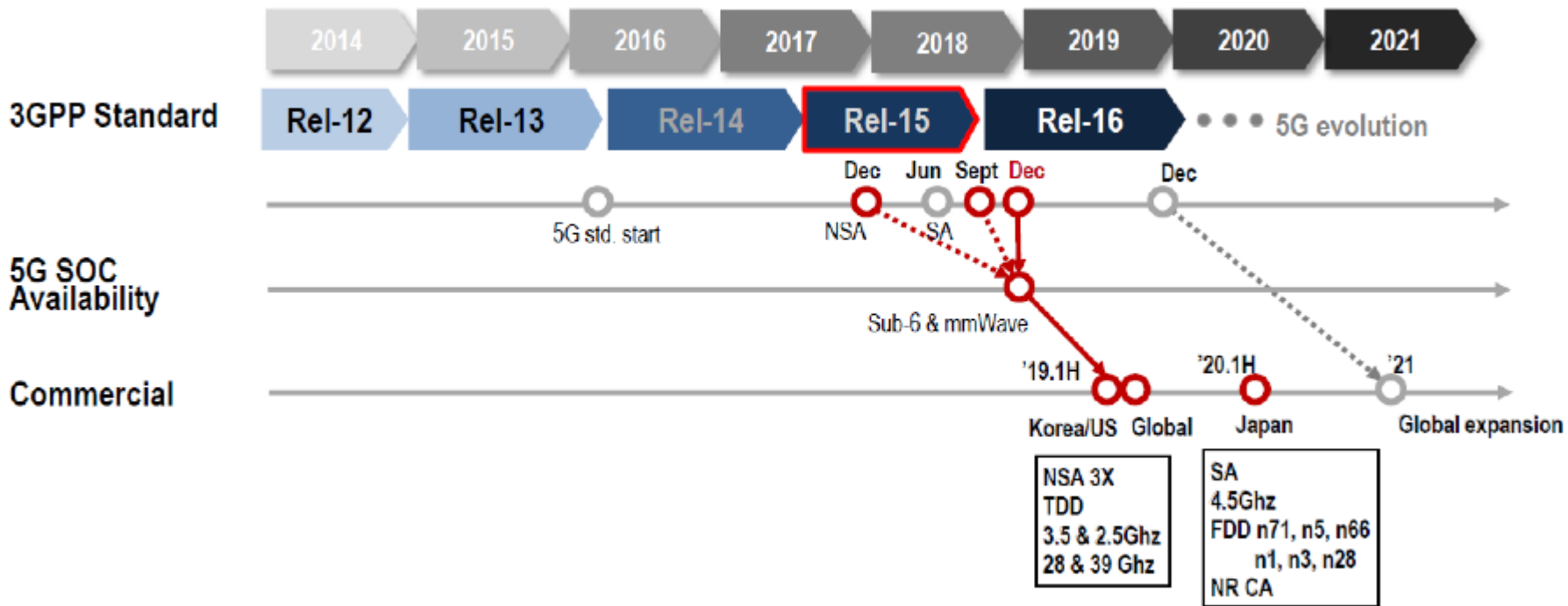

# 5G KPIs

>10 times better performance than LTE in pursuit of eMBB, mIoT & uRLLC

## 5G main drivers

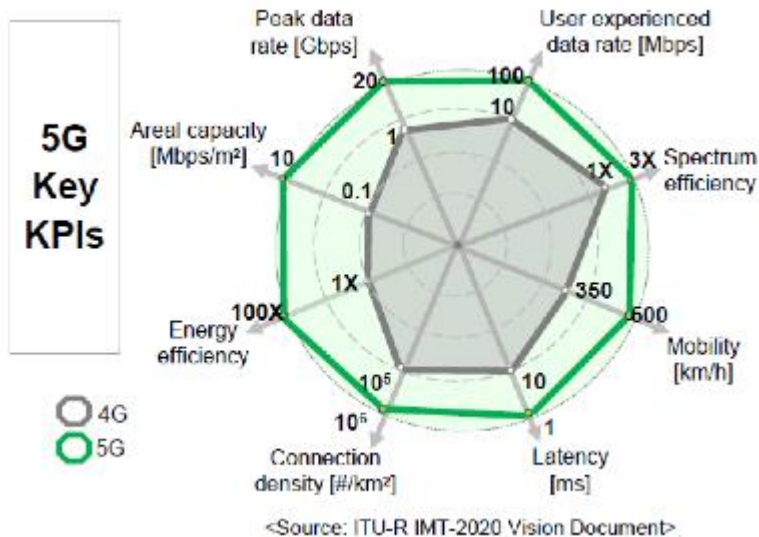

## 5G technology configuration

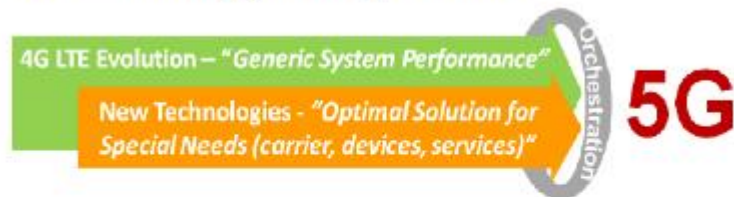

- Revolution in core network technology, e.g., NW slicing
- Evolution in radio access, i.e., LTE tech is mostly reused
- LTE is backbone technology
- LTE will have long life, coexisting with 5G

# 5G's three main attributes

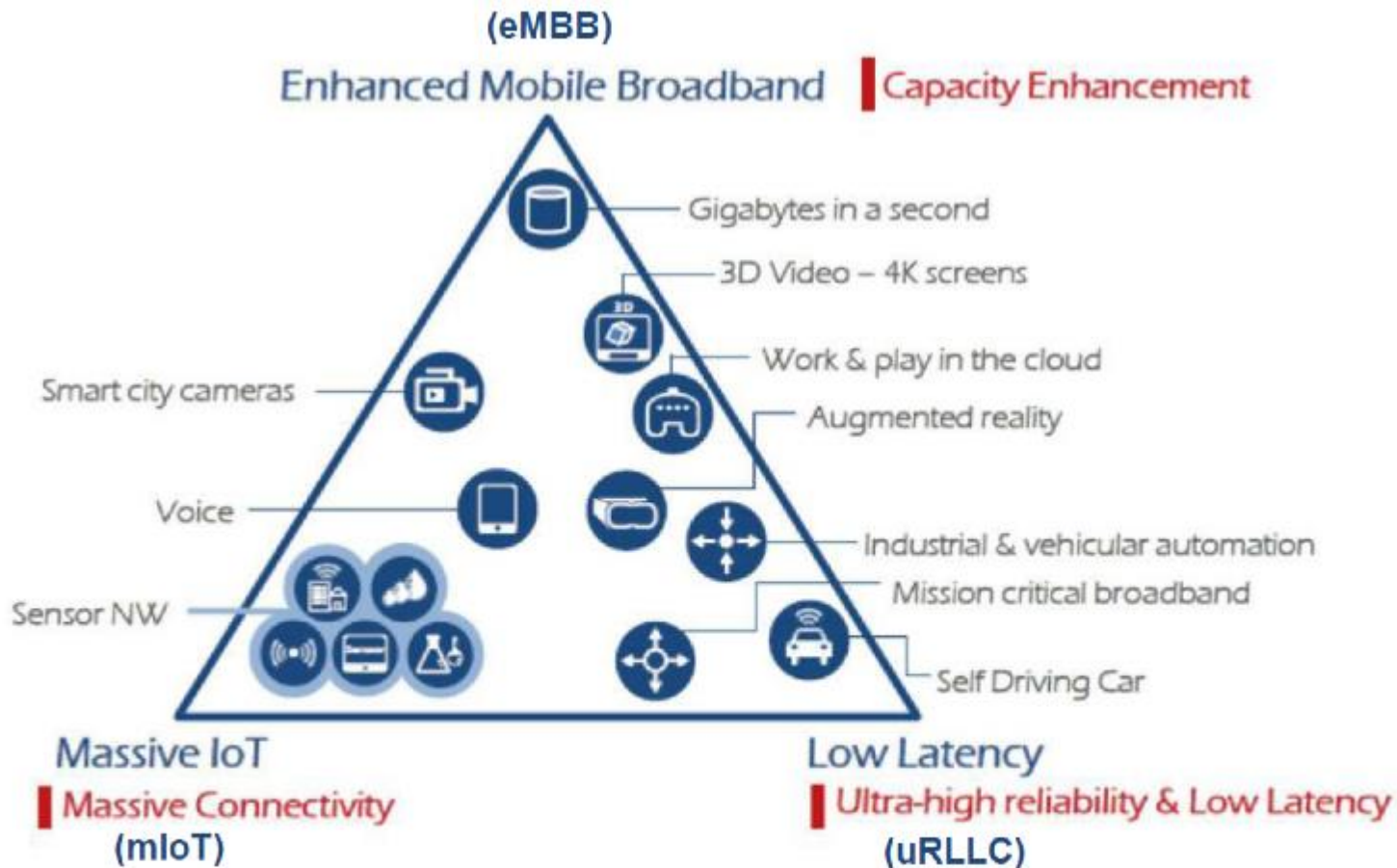

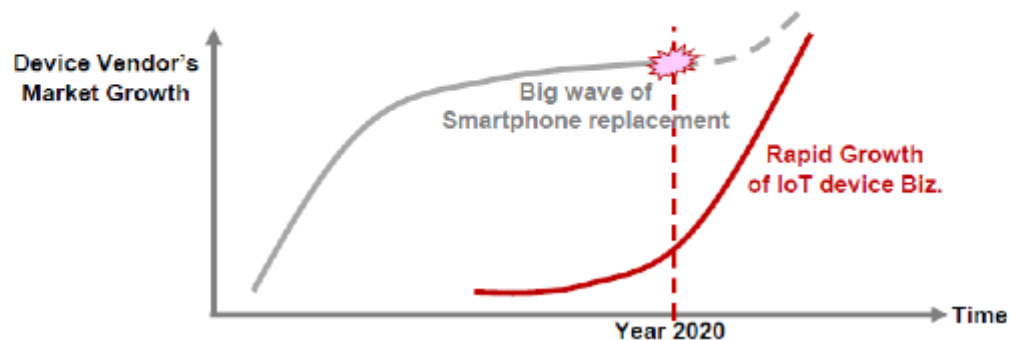
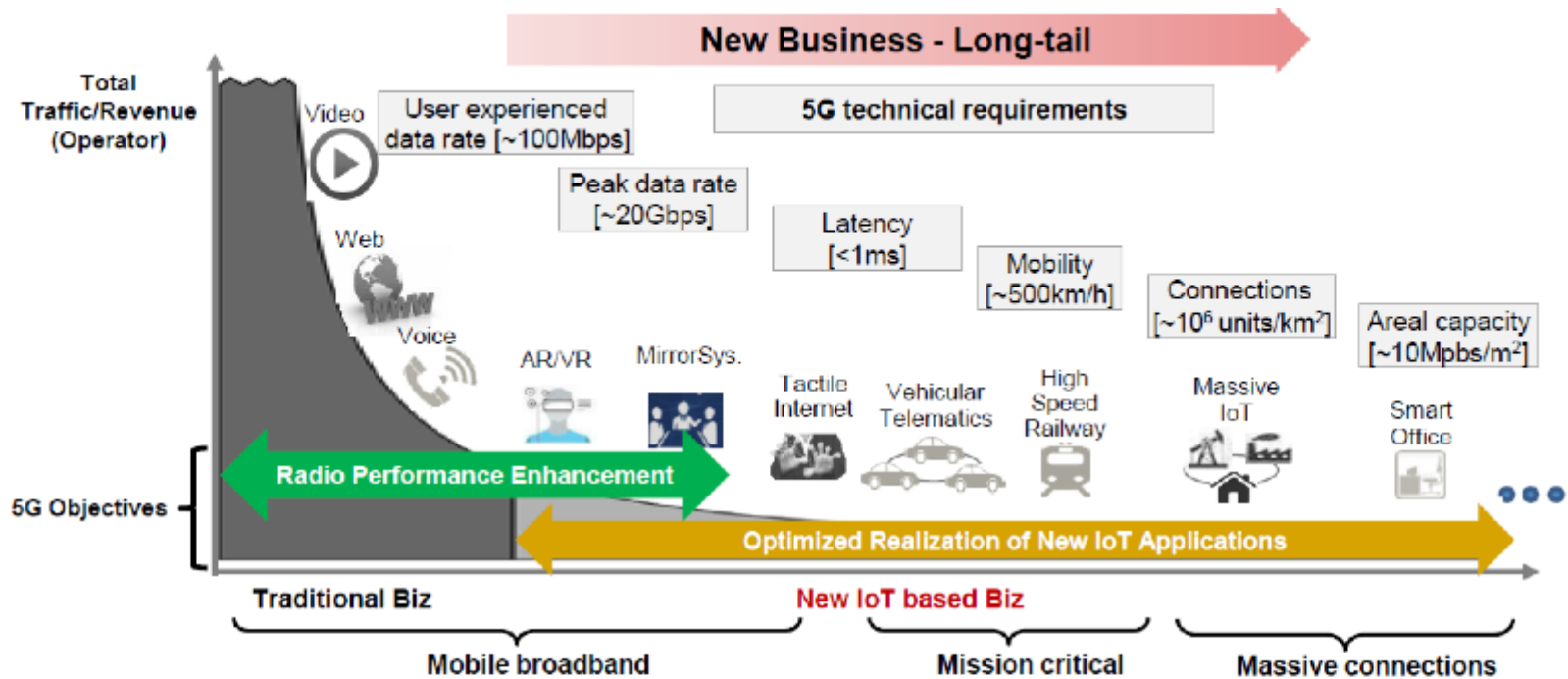

(Source: ETRI graphic, from ITU-R IMT 2020 requirements)

# 5G business opportunity

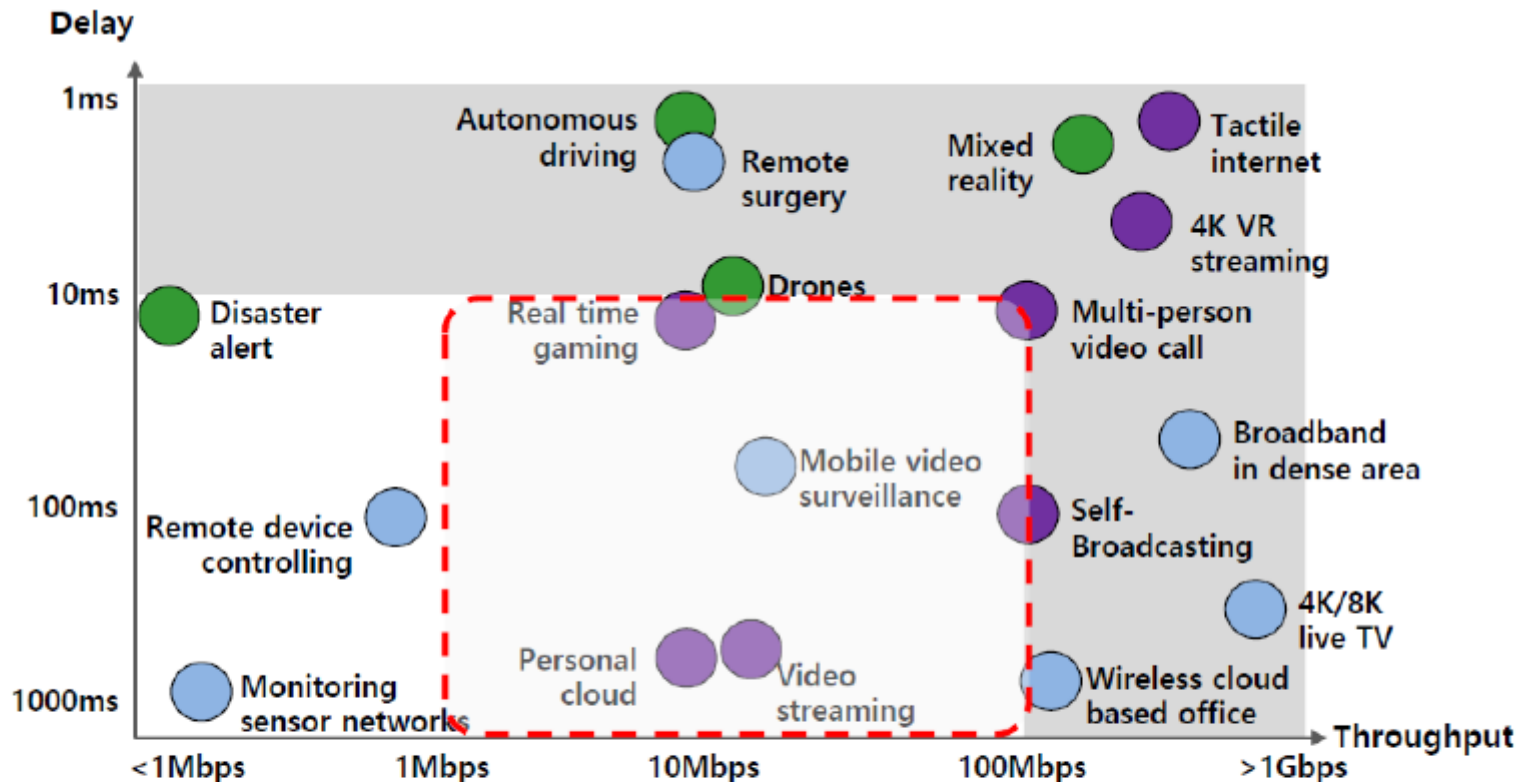

# Service categorization



 Services that can be delivered by LTE

 Services that could be enabled by 5G

 Fixed

 Nomadic

 On the go

# How to increase data rate ? (1/3)

스마트폰

K.BENCH DIGITAL

Home > 모바일 > 스마트폰/패드 > 스마트폰, 주요뉴스

속도가 무려 '500Mbps'...SK텔레콤, 'LTE-A Pro' 6월 1일부터 서비스

2016/05/23 11:15:18

SK텔레콤은 이러한 환경 변화에 대응하여 6월 1일부터 자사 네트워크에 50MHz 대역폭의 3Band CA 기술과 LTE-A Pro 요소기술인 256QAM을 적용하여 서비스할 계획이라고 23일 밝혔다.

3Band CA로 다운로드 기준 최대 375Mbps가 제공되며, 여기에 256QAM으로 33% 개선 효과가 더해져 500Mbps의 속도가 서비스 가능해진다. 256QAM은 삼성 갤럭시S7 및 S7 Edge, LG G5 등 최신 스마트폰에 적용되어 있다.

**(1) Frequency Band**  
**10MHz X 3**

## **(2) Modulation**

**LTE:**            **64QAM** (신호  $2^6 \rightarrow 6$ 비트)  
**LTE-A Pro:** **256QAM** (신호  $2^8 \rightarrow 8$ 비트)  
                      **속도  $8/6 = 1.33$  배 개선**  
**5G:**             **512QAM** (신호  $2^9 \rightarrow 9$ 비트)



# How to increase data rate ? (2/3)

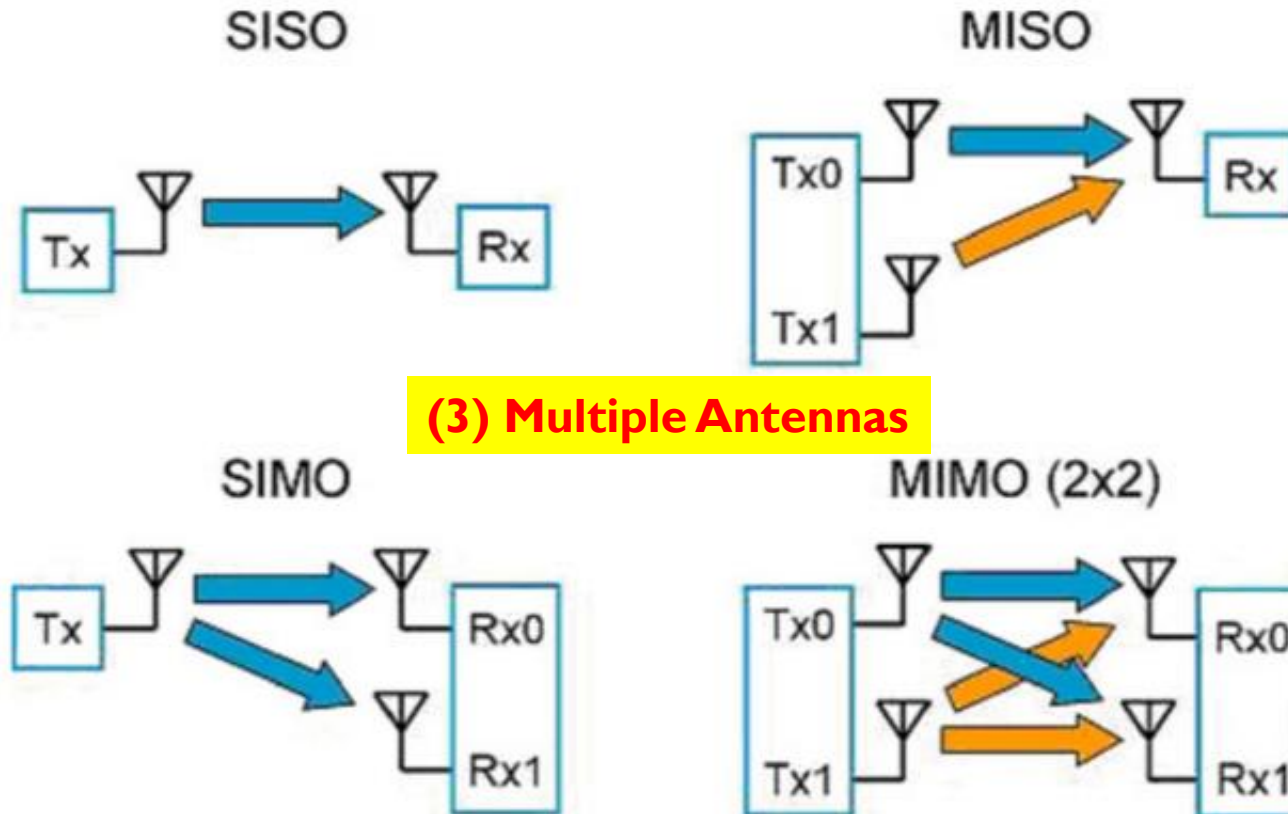

- **SISO:** Single Input Single Output
- **MIMO:** Multiple Input Multiple Output



# MIMO

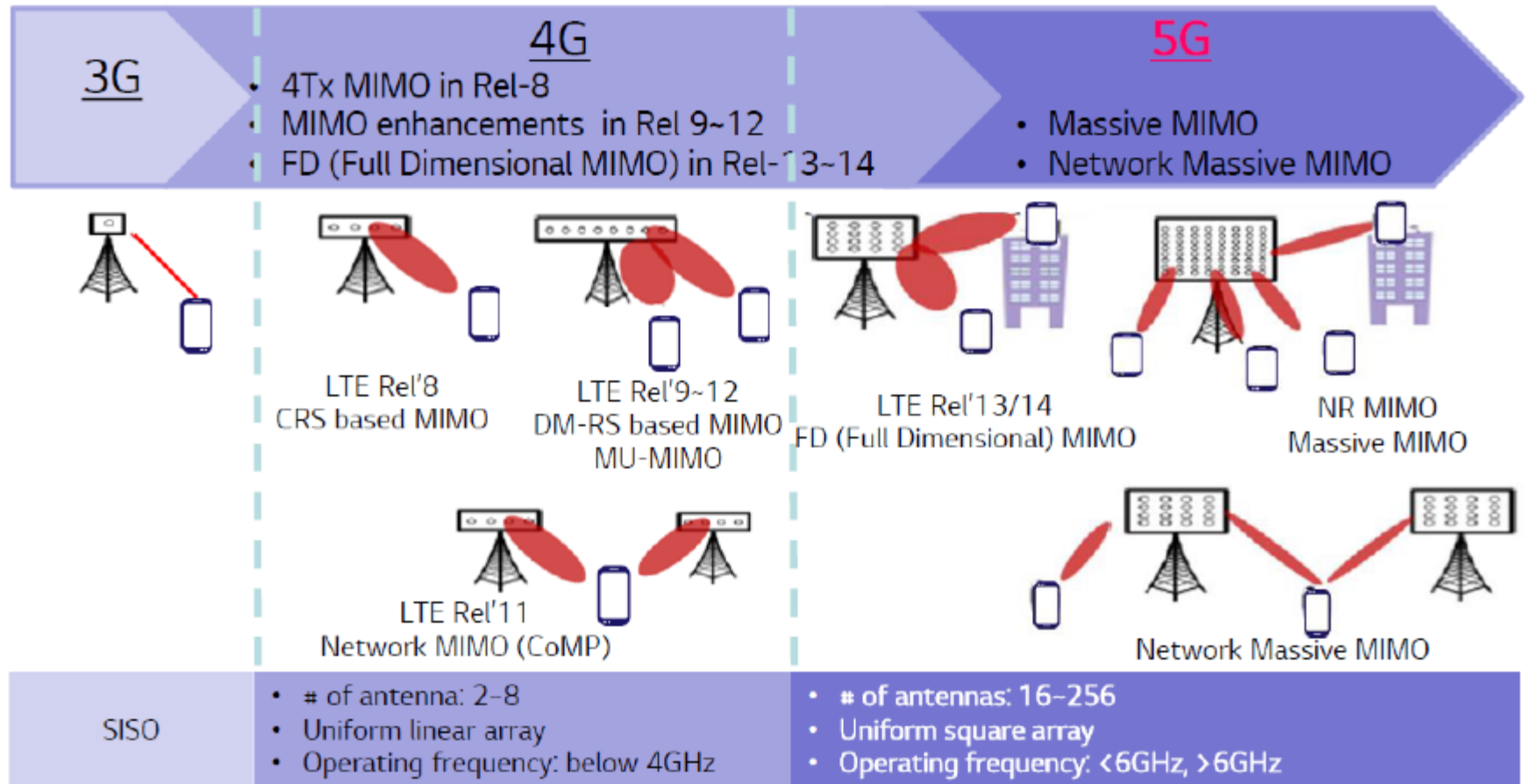

# How to increase data rate ? (3/3)

## (4) Scheduling

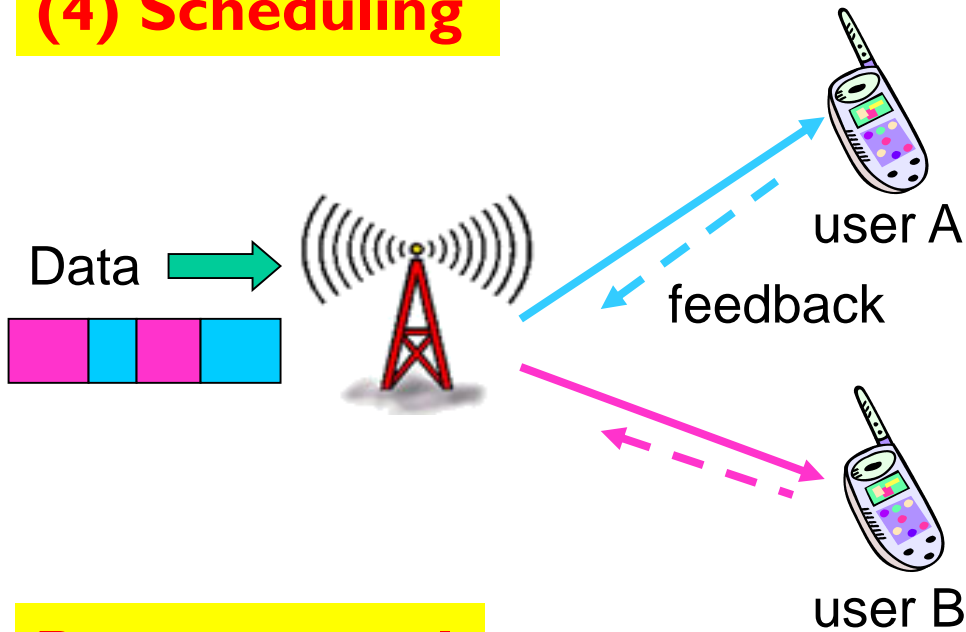

## Power control

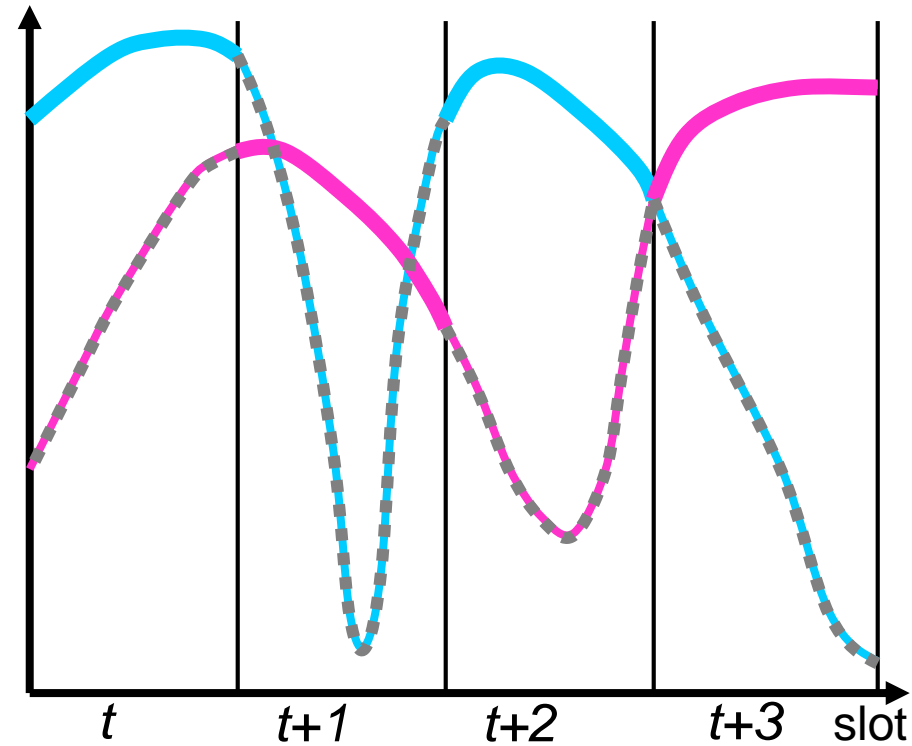

# 5G NR Subcarrier spacing

- NR utilizes **scalable numerology** (subcarrier spacings, CP length) and **flexible slot (mini-slot) structure** optimized for various services including URLLC in time & frequency domain

Subcarrier Spacing:  $f_0 * 2^m$  with  $f_0 = 15$  kHz and scaling factor is  $2^m$  with  $m \{-2, 0, 1, \dots, 5\}$

m =	-2	0	1	2	3	4	5	...
Subcarrier Spacing [kHz]	3.75	15	30	60	120	240	480	...
Symbol Length [ $\mu$ s]	266.67	66.67	33.33	16.67	8.333	4.17	2.08	...

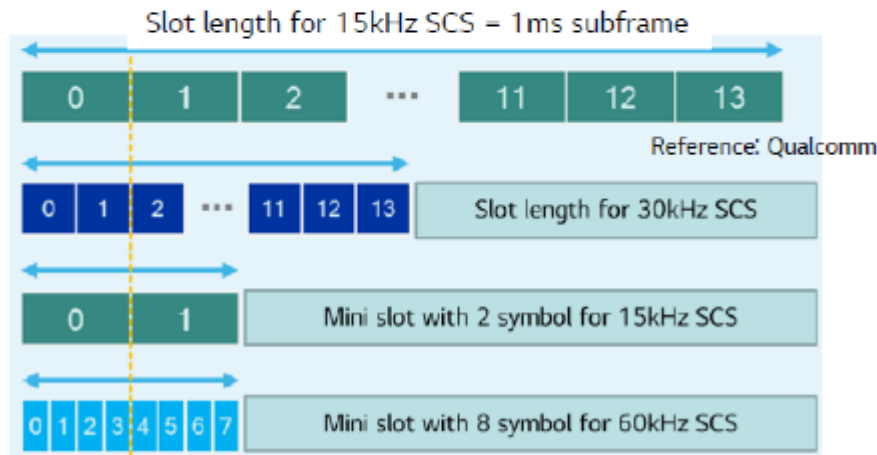

Slot & Mini slot (scalable slot length)



DL-UL Flexible Slot Configuration

# Cloud RAN

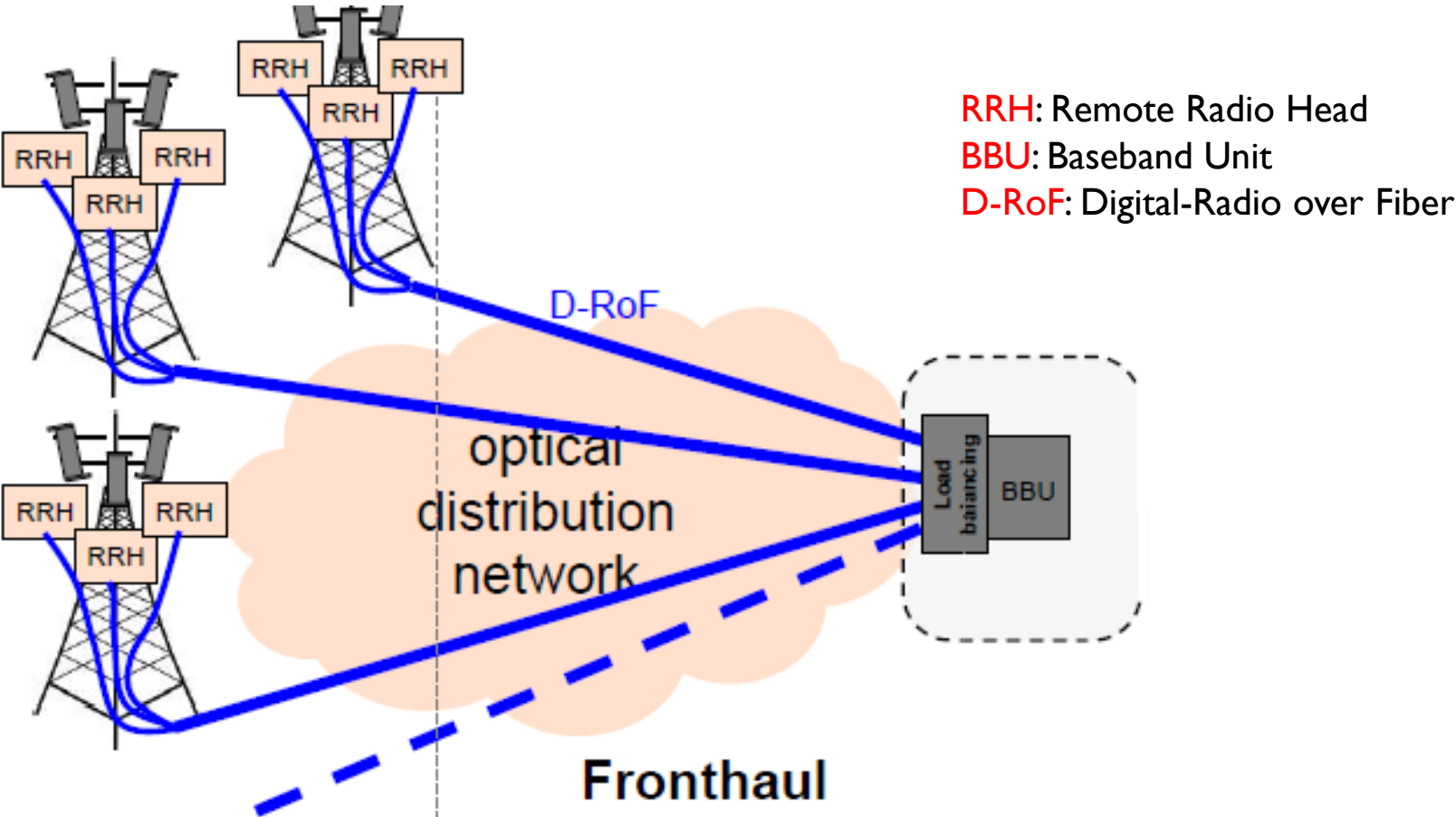

# Cloud RAN - RRH



# Cloud RAN

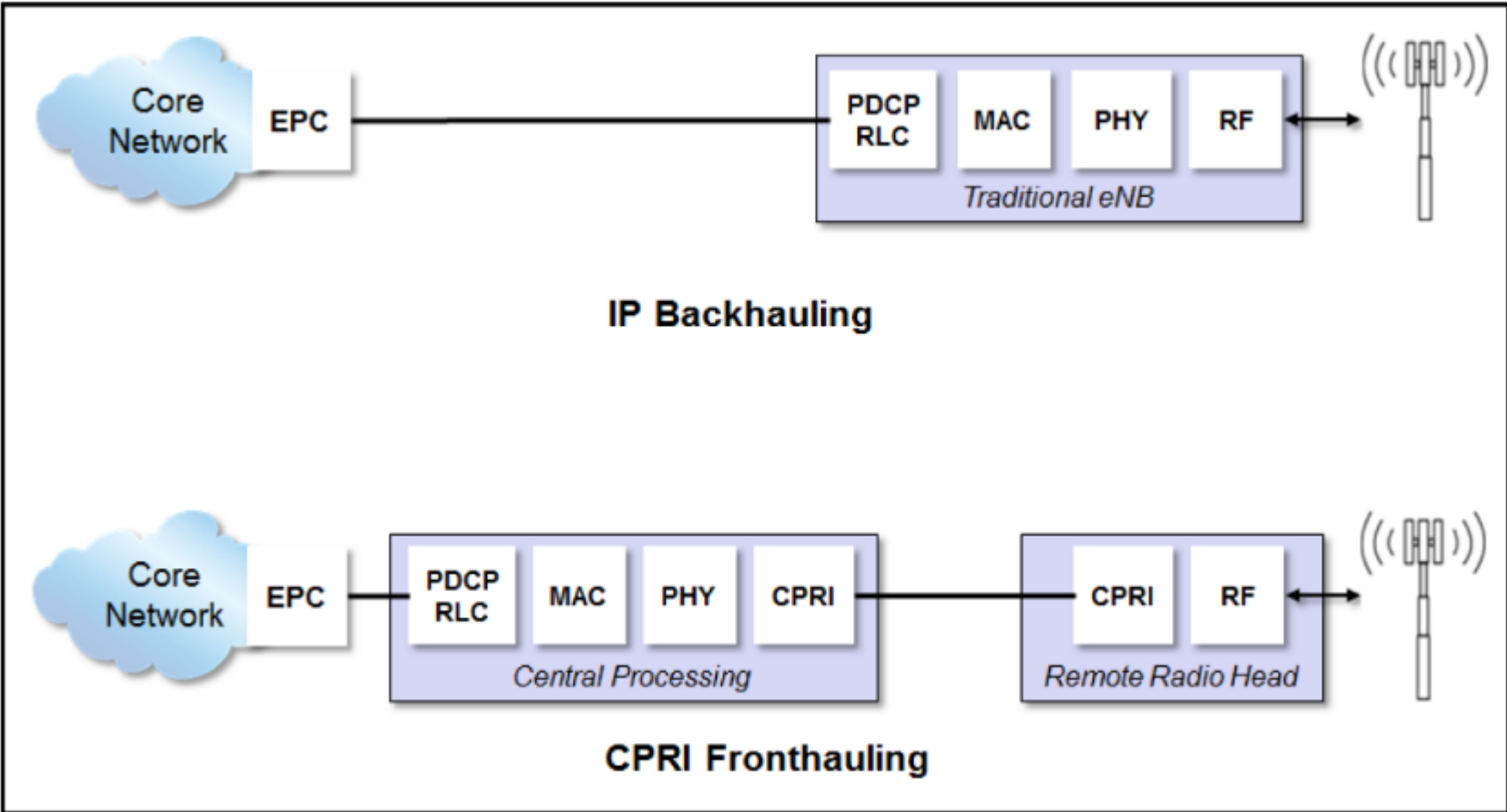

# Network slicing

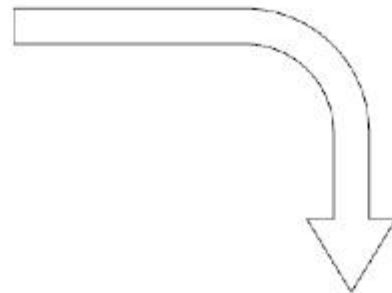
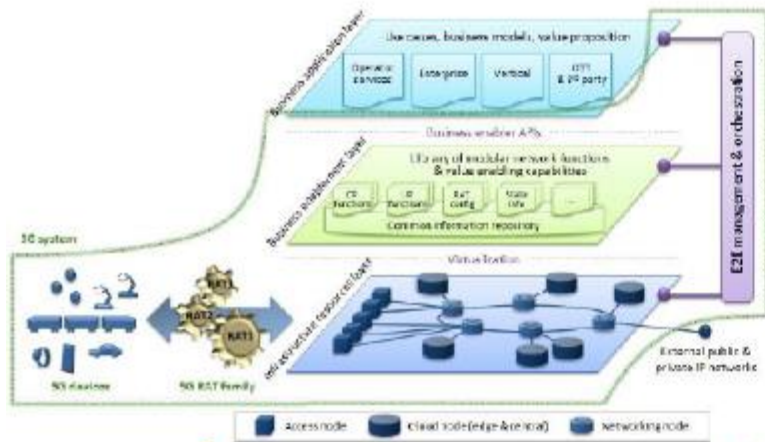

**SW based NFV (Network Function Virtualization)  
+ Network slicing  
+ RAT selection**

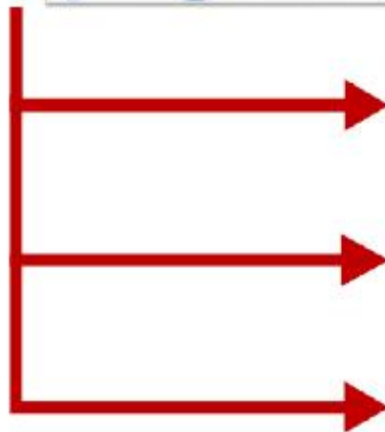

**Configure a virtual 5G system per device type and service grade (5G slice)**

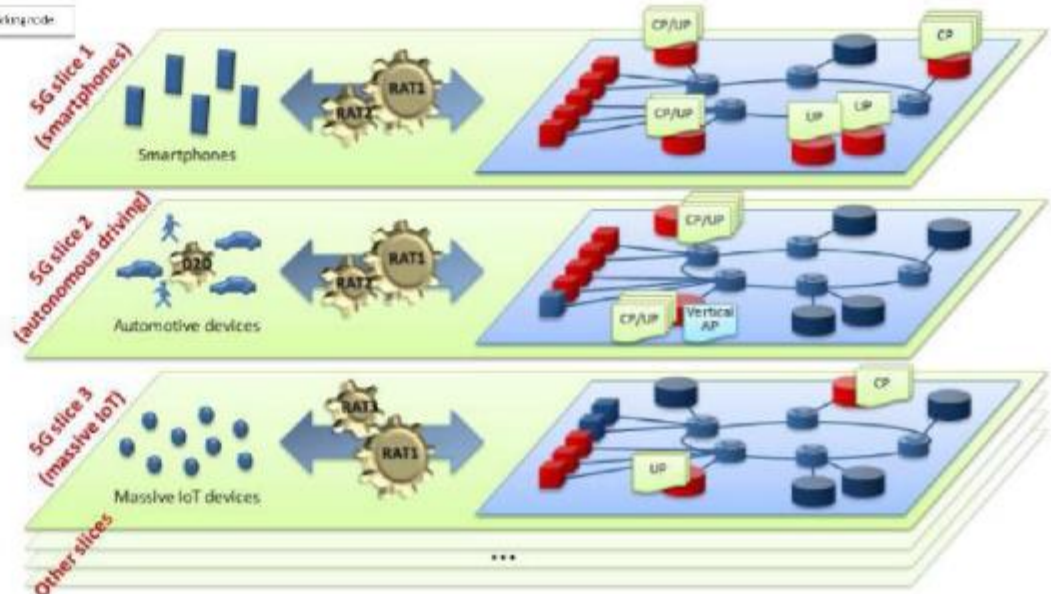

# Edge computing

## Edge Computing Model

2016

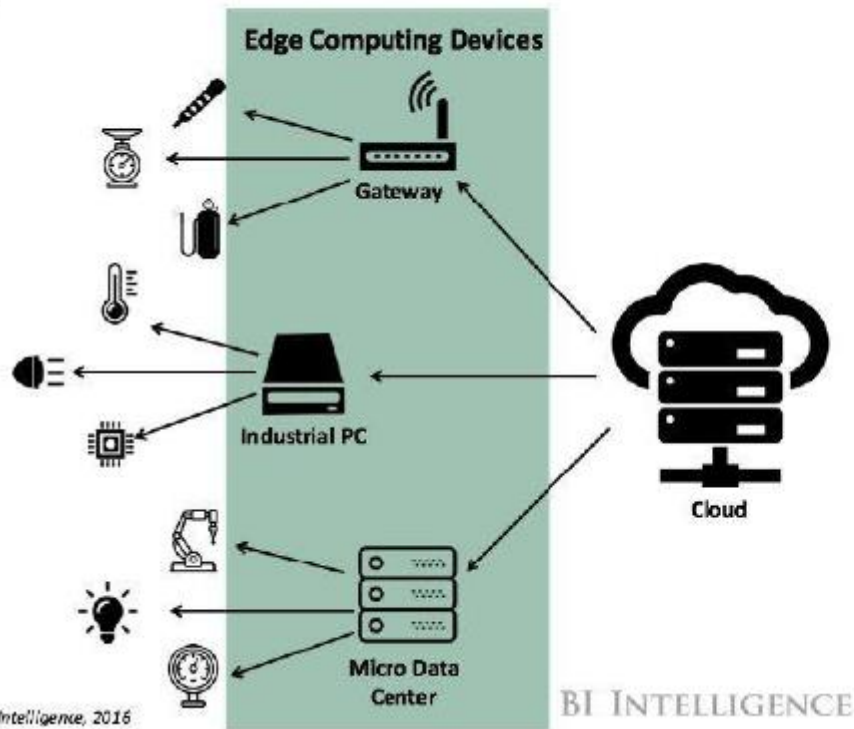

Source: BI Intelligence, 2016

